

## 60 MARTIN PLACE SYDNEY

### RAIL INFRASTRUCTURE IMPACT FROM PROPOSED DEVELOPMENT STRUCTURAL REPORT

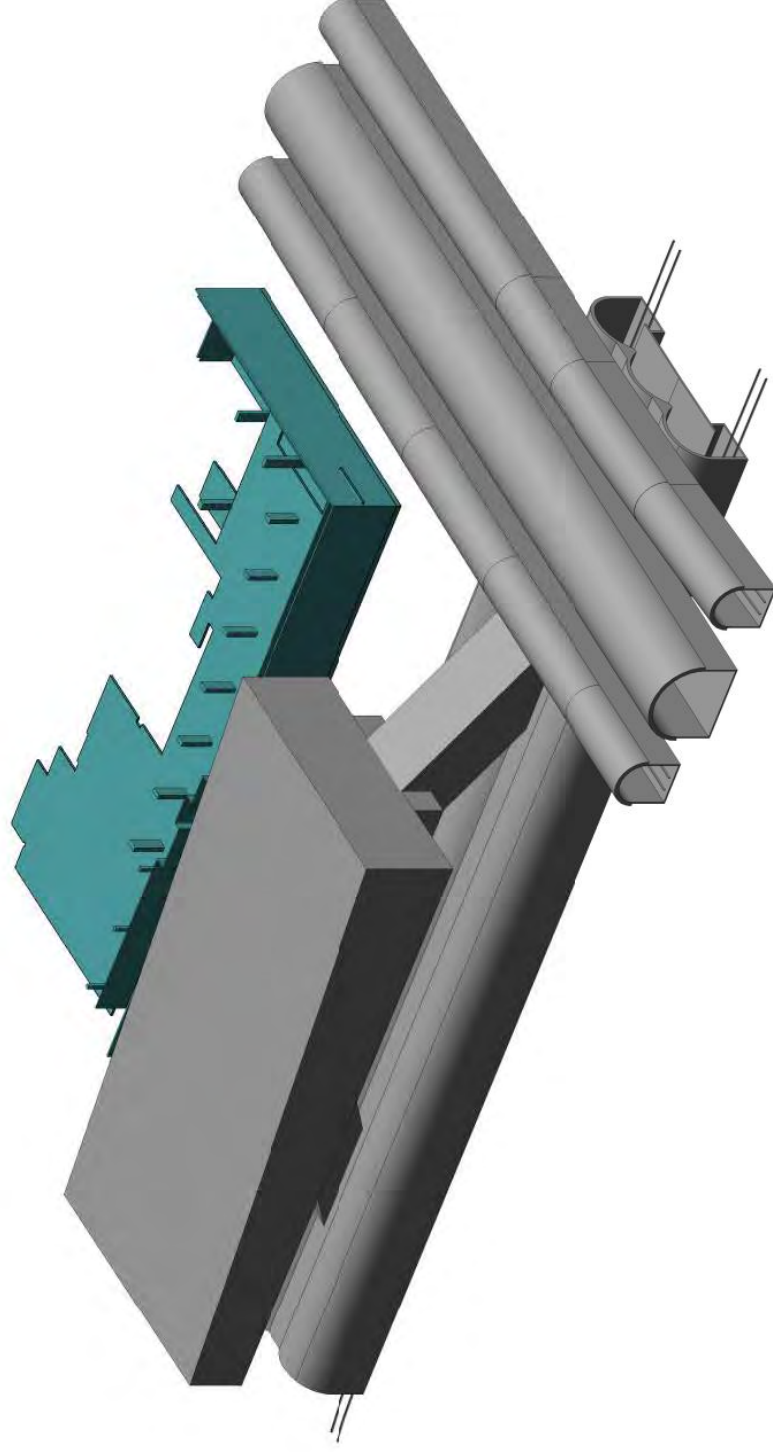

Prepared for: **Investa Nominees Pty Ltd ATF 60 Martin Place Trust. (“Investa”)**

By: **Enstruct Group**

Revision: **B**

**June 2013**

## ISSUE AUTHORISATION

**PROJECT:**  
Project No:

Rev	Date	Purpose of Issue /Nature of Revision	Prepared by	Reviewed by	Issue Authorised by
A	12/06/13	Draft Issue Issued for Stage 1 DA	RCC	TBB	RCC
B	19/06/13		RCC	TBB	RCC

Enstruct group P/L  
Level 4 – 2 Glen St  
Milsons Point  
Sydney NSW 2061  
Australia.  
Telephone (02) 8904-1444  
Facsimile (02) 8904-1555

## Executive Summary

Enstruct has been commissioned by Investa Property Group and Gwynvill Group to assist with the preparation of the LEP Amendment and Stage 1 Development Application for 60 Martin Place, Sydney. This development is adjacent to key Railcorp Infrastructure, namely the City Circle tunnels and the Eastern Suburbs Rail Line, ie the Martin Place Station Cavern and adjoining tunnels.

On 2 May 2013, Enstruct and Investa met with Railcorp to provide an overview of the proposed development and agree ongoing deliverables to enable in principle support by Railcorp for the Stage 1 Development Application. A commitment was made to prepare a Design Report for distribution to Railcorp and inclusion in the Stage 1 DA. This report addresses the key issues which will affect the interaction of the proposed development and the adjacent RailCorp infrastructure, namely : the site geology, existing buildings and infrastructure, proposed development structural analysis, demolition methodology, Railcorp requirements and requirement for further analyses during subsequent planning stages.

The proposed 30 Storey office tower, adopts the existing basement excavation, and will be constructed on a conventional sandstone foundation, within a typical Sydney CBD subgrade profile which will require perimeter retention. The building foundations will lie within the Railcorp designated zones of influence with respect to both the City Circle Line and the Eastern Suburbs Rail Line tunnel network. These tunnels have been mined in rock and contain rock bolting to ensure the integrity of their roofs.

Railcorp have provided Enstruct with all available plans and set out drawings for both the City Circle Line ( constructed 1920s) and Eastern Suburbs Line ( constructed in two stages: 1950s and 1970s). A detailed 3D computer model has been generated containing both the existing 60 Martin Place Development and the Railcorp Infrastructure, as a basis for this study.

A preliminary structural and geotechnical study has found that the demolition of the existing building and the construction of the proposed building would not generate stresses or movements within the rock profile which would compromise the capacity of the existing tunnels or station cavern. Furthermore, retention of the existing 60 Martin Place reinforced concrete basement walls would adequately protect the adjacent Martin Place Station infrastructure both during construction and in service. Detailed analyses would be required to determine the effect of further basement excavation.

The study demonstrates that the Stage 1 Development Application will not have any negative impact on the adjacent Railcorp infrastructure.

## TABLE OF CONTENTS

1	Introduction.....	2
2	Site .....	2
2.1	Topography .....	2
2.2	Geology .....	2
3	Existing Development.....	4
3.1	Basement.....	4
3.1.1	Construction .....	4
3.1.2	Eastern Boundary .....	4
3.1.3	Northern Boundary .....	4
3.1.3.1	Eastern Section .....	4
3.1.3.2	Western Section .....	4
3.1.4	Western Boundary .....	4
3.1.5	Southern Boundary.....	4
3.2	Foundations .....	4
3.3	Superstructure.....	4
4	RailCorp Infrastructure.....	17
4.1	City Circle Line.....	17
4.2	Eastern Suburbs Rail Line.....	17
4.3	Easements .....	17
5	Proposed Development.....	23
5.1	Basement.....	23
5.2	Foundation.....	23
5.3	Superstructure .....	23
5.4	Demolition Methodology .....	23
5.5	Construction Methodology.....	23
6	Study .....	26
6.1	RailCorp Briefing.....	26
6.2	Existing Drawings.....	26
6.3	3D Modelling.....	26
6.4	Engineering Analysis.....	26

6.4.1	Geotechnical Desktop Study .....	26
6.4.2	Structural Analysis .....	26
6.4.3	Development/Infrastructure Interaction .....	26
7	Project Delivery .....	30
7.1	Process .....	30
7.2	Studies and Reporting to RailCorp .....	30
	Appendix-A – Parsons Brinckerhoff Report	
	Appendix B – RailCorp Meeting Minutes 5 <sup>th</sup> May 2013	

## 1 Introduction

60 Martin Place is a landmark site for a commercial office tower, located on the north western corner of Macquarie Street and Martin Place. A rectangular site bounded on three sides by Macquarie Street, Martin Place and Phillip Street, and on the fourth side by St Stephens Church and the 126 Phillip Street Commercial office tower.

The site currently contains a thirty storey commercial office tower built in the early 70s with a three level basement. This steel frame superstructure is supported on pad footings founded on rock and reinforced concrete retaining walls provide perimeter support.

The proposed building will provide a building of similar dimensions, with some 32,500 square metres of net leasable area over 28 stories (approx. 1200-1250m<sup>2</sup> typical floor). It is expected that the structural system will be post tensioned concrete floor plates, a reinforced concrete frame – columns and core, founded on pad foundations on rock.

The site is adjacent to two key pieces of Railcorp infrastructure: the City Circle line to the east and the Eastern Suburbs Rail Line (Martin Place Cavern and adjoining tunnels) to the south. The City Circle line contains three tunnels constructed in the 1920s and the Eastern Suburbs Line was partially constructed in the early 1950s and completed in the late 1970s. In both cases the tunnels have been mined in sandstone, and the Martin Place station cavern and ramps are also mined in rock.

Whilst the proposed development will not extend the existing basement and will replace the existing superstructure with a building of similar form it is necessary to study the development as both the basement and the building foundations lie within the designated Railcorp zones of influence for both the City Circle line and the Eastern Suburbs line.

Based on a knowledge of the tunnel / station cavern geometry, site geology and preliminary structural analyses, the study will determine the effects of the demolition of the existing building, and the construction of the proposed development on adjacent Railcorp infrastructure and compare these effects against established performance criteria for tunnel and cavern structures.

## 2 Site

### 2.1 Topography

The site is located on the north western corner of Macquarie Street and Martin Place and is bounded to the west by Phillip Street and to the north by St Stephens Church and the 126 Phillip Street development. The 2561 square metre site is approximately rectangular in form with a southern boundary of approximately 71.1 metres and a western boundary of approximately 37.8 metres. The site falls to the west some 4 metres from Macquarie Street to Phillip Street.

### 2.2 Geology

The site contains a typical Sydney CBD geotechnical profile, with some 4 to 6 metres of residual material overlying weathered rock, which increases in strength with depth. The rock is known to be locally faulted in this area (Martin Place Joint Swarm) and as is typical with Sydney sandstone in the CBD contains significant horizontal compression stresses. The water table is driven by surface inflows and will vary with the season. It is expected that a perched water table level will typically exist at the top of rock level and modest inflows into the site will occur and be managed via a drained basement arrangement. See Figure 1 below for geological and geotechnical plan in the vicinity of 60 Martin Place.



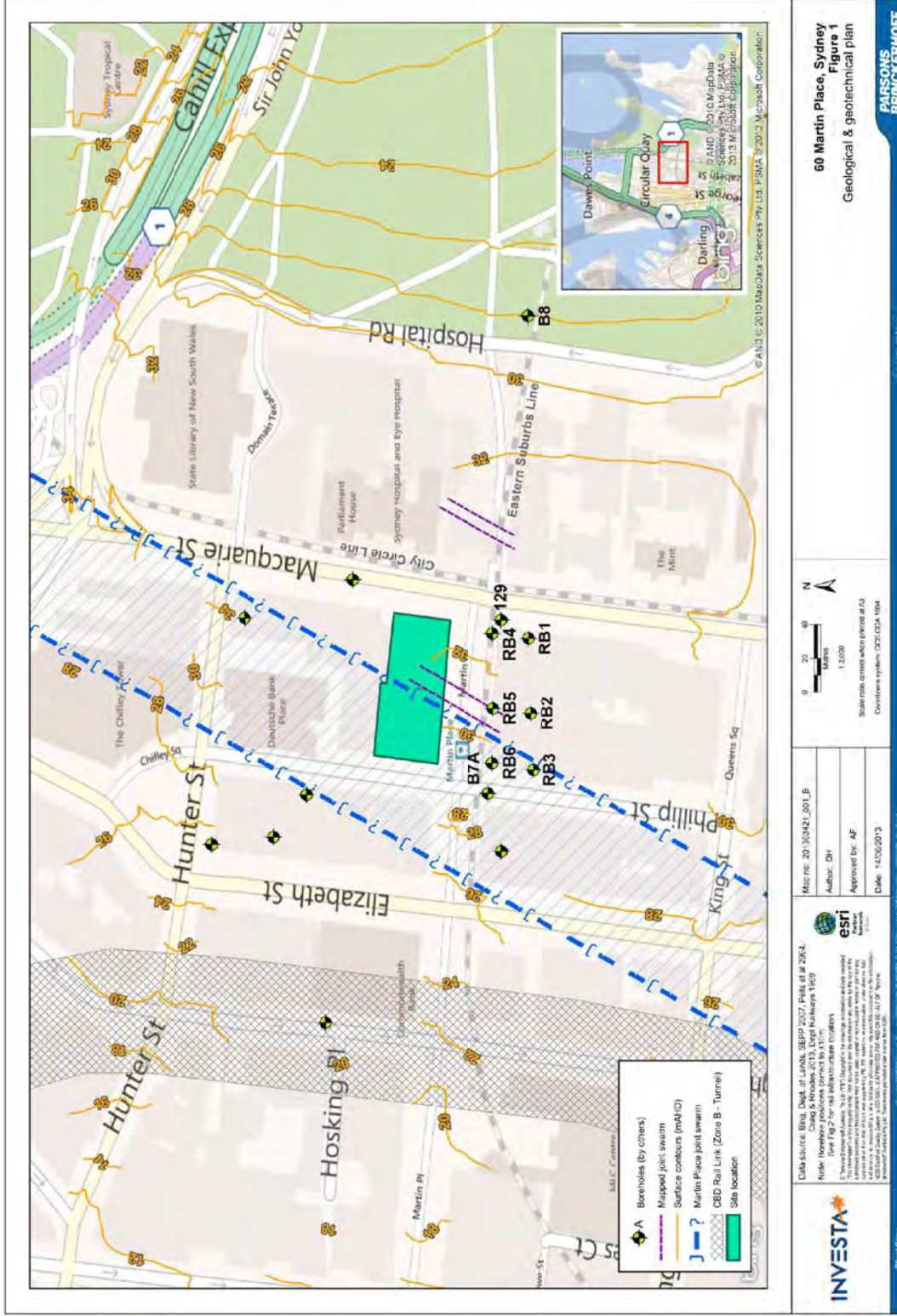

Figure 1 – 60 Martin Place Sydney Geological and Geotechnical Plan

### 3 Existing Development

#### 3.1 Basement

##### 3.1.1 Construction

The existing three level basement contains a continuous 200mm thick reinforced concrete retaining wall over its full perimeter. This wall retains the upper level residual material and also provides a separation wall to the adjacent Martin Place Station cavern. Refer to Figure 2 below for plan of existing basement retaining walls on the site.

##### 3.1.2 Eastern Boundary

Retains Macquarie Street along its full length and it is likely that significant in ground services will be located to immediately to the east of the wall. Refer to retaining wall section W7 shown in Figure 4 below which shows the existing retaining wall arrangement along the eastern boundary.

##### 3.1.3 Northern Boundary

##### 3.1.3.1 Eastern Section

Retains St Stephens Church to the east: A detailed investigation of the church has not yet been carried out, however, it is most likely to contain a single level basement and load bearing walls founded on rock, and as such should not be sensitive to the proposed development. Refer to retaining wall sections W4, W4A, W5 & W6 in Figure 3 below which shows the existing retaining wall arrangement along the northern boundary adjacent to St Stephens Church.

##### 3.1.3.2 Western Section

Adjoins 126 Phillip Street along the western section of this boundary: The existing basements of 126 Phillip Street and 60 Martin Place are excavated in rock and at approximately the same level. Refer to retaining wall sections W1, W2 & W3 in Figure 3 below which shows the existing retaining wall arrangement along the northern boundary adjacent to 126 Phillip St. Figures 6 & 7 below show the construction of 126 Phillip St along the 60 Martin Place Boundary.

##### 3.1.4 Western Boundary

Retains Phillip Street along its full length and it is likely that significant in ground services will be located to immediately to the west of the wall. Refer to retaining wall sections W11, W12, & W12A in Figure 4 below which shows the existing retaining wall arrangement along the western boundary to Phillip St.

##### 3.1.5 Southern Boundary

This is the most complex and important boundary in that it adjoins the Martin Place station cavern and contains egress stairs from the station. Refer to retaining wall sections W8, W8A, W9, W10, W10A, W10B, W10C, W10D & W10E in Figures 4 & 5 below which shows the existing retaining wall arrangement along the southern boundary adjacent to Martin Place Station. Figures 8 to 12 show sections through the existing 60 Martin Place and Martin Place station box construction.

For the western section of this boundary the 60 Martin Place excavation and Martin Place station box are aligned and due to this neither of the 60 Martin Place or Martin Place Station walls are retaining. Both walls will be left in place for the proposed development on the site ensuring no disturbance to the Martin Place Station occurs during or after construction of the new tower.

The eastern section of this boundary extends beyond the Martin Place station box and as such is retaining soil and will be retaining both during construction and in the final arrangement of the proposed development. During construction this wall will be temporarily ground anchored to allow demolition of the existing building and then in the final arrangement of the development the wall will be propped by the new basement slabs to allow the temporary anchors to be removed.

### 3.2 Foundations

The existing building tower columns are supported on pad foundations founded on high strength sandstone, the perimeter retaining walls are founded on strip footing constructed within the site. The lowest basement slab is a 125 mm thick slab on grade. Refer to Figure 2 below for general arrangement of existing building foundations.

### 3.3 Superstructure

The basement is a steel framed structure supporting reinforced concrete floor plates, which provide lateral support to the perimeter retaining walls. The tower structure is also steel framed with reinforced concrete floor plates. The column grid is approximately 6 by 9 metres and the core is located centrally on the building's northern face. The steel framed superstructure provides the buildings lateral capacity as well as supporting gravity loads. Refer to Figure 13 below for Level 13 floor framing of the existing building which is indicative of the framing on the typical floors of the building.

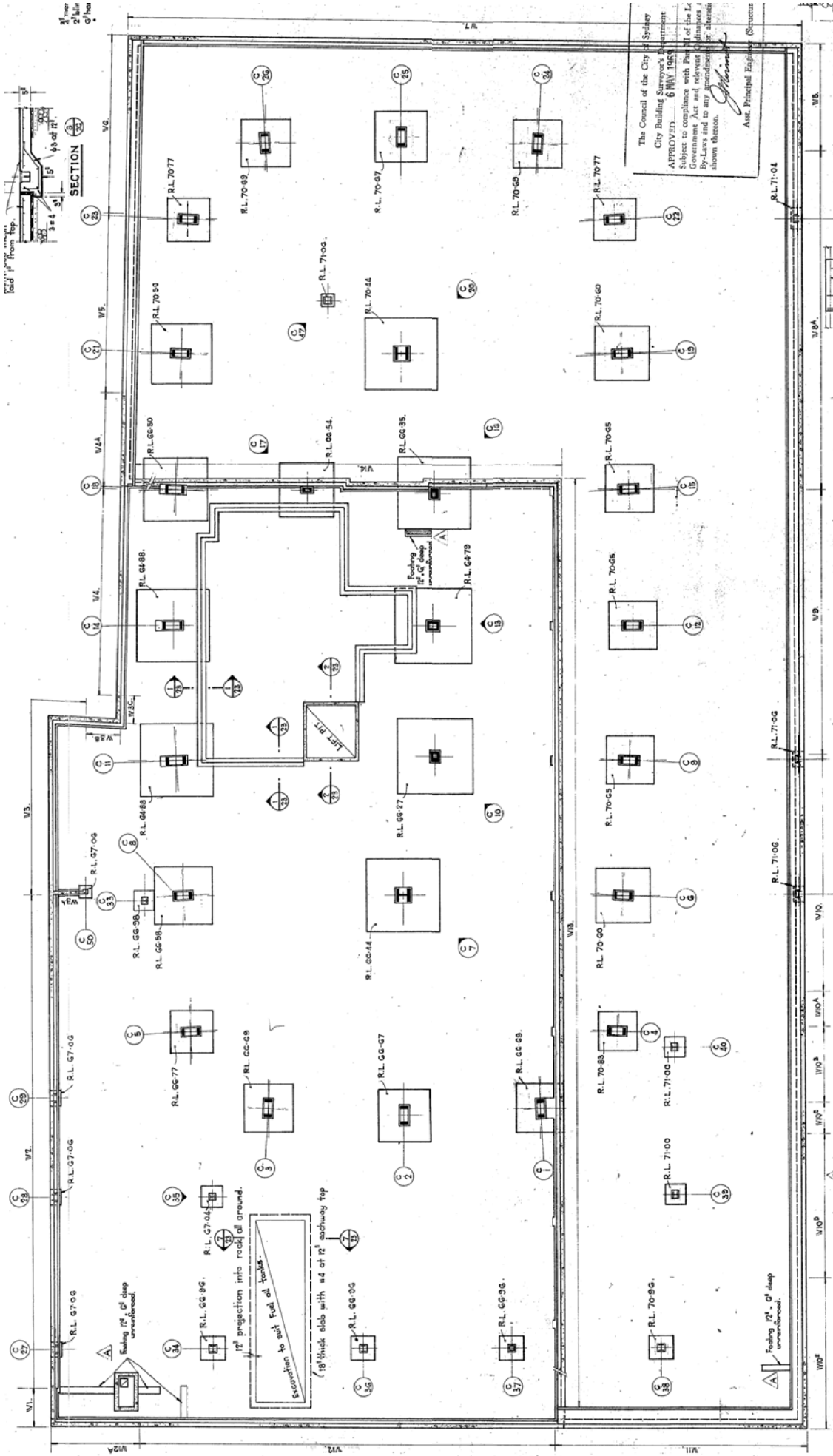

Figure 2 – Existing Foundation and Retaining Wall Plan



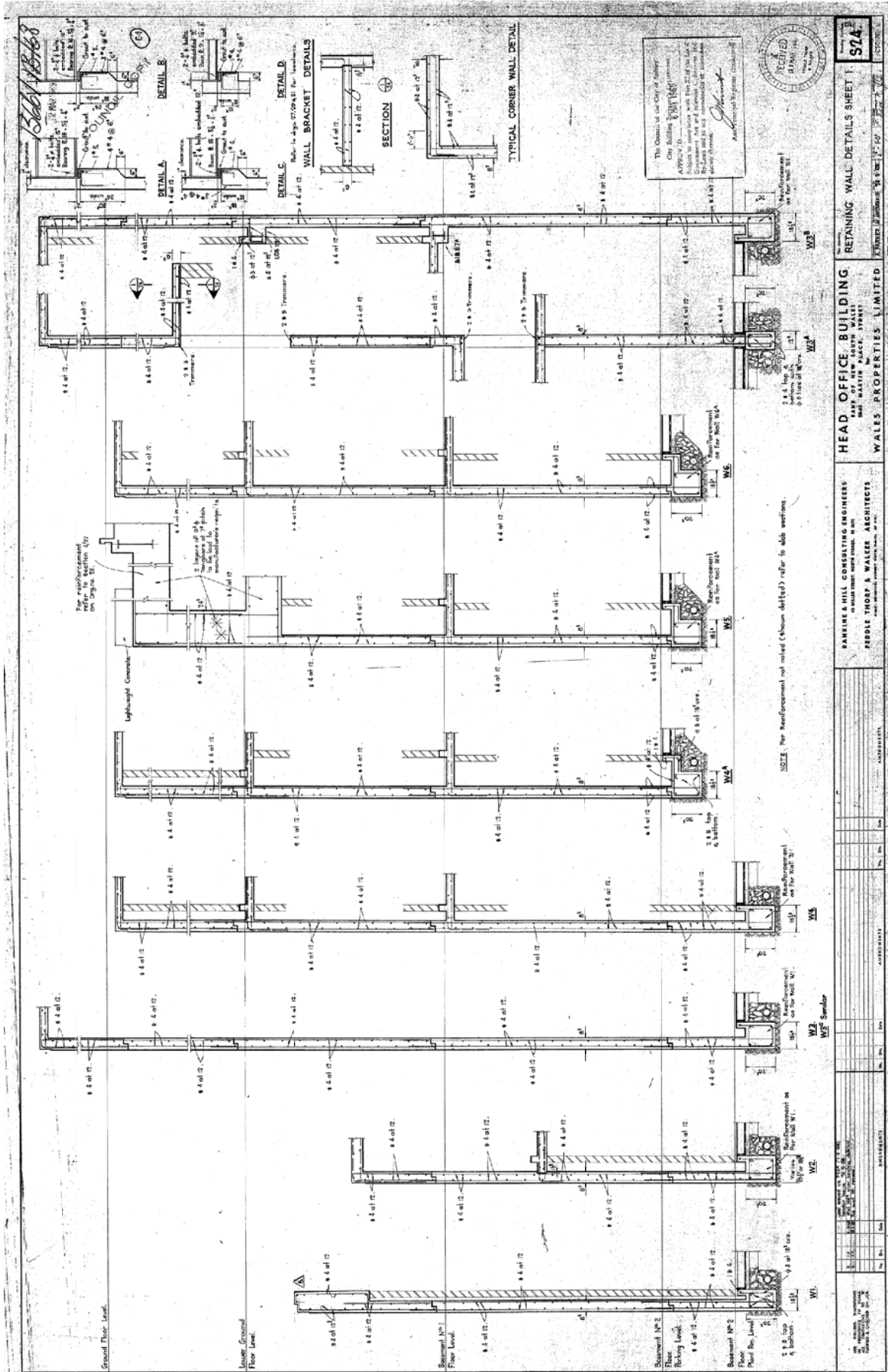

Figure 3 – Existing Retaining Wall Sections Sheet 1

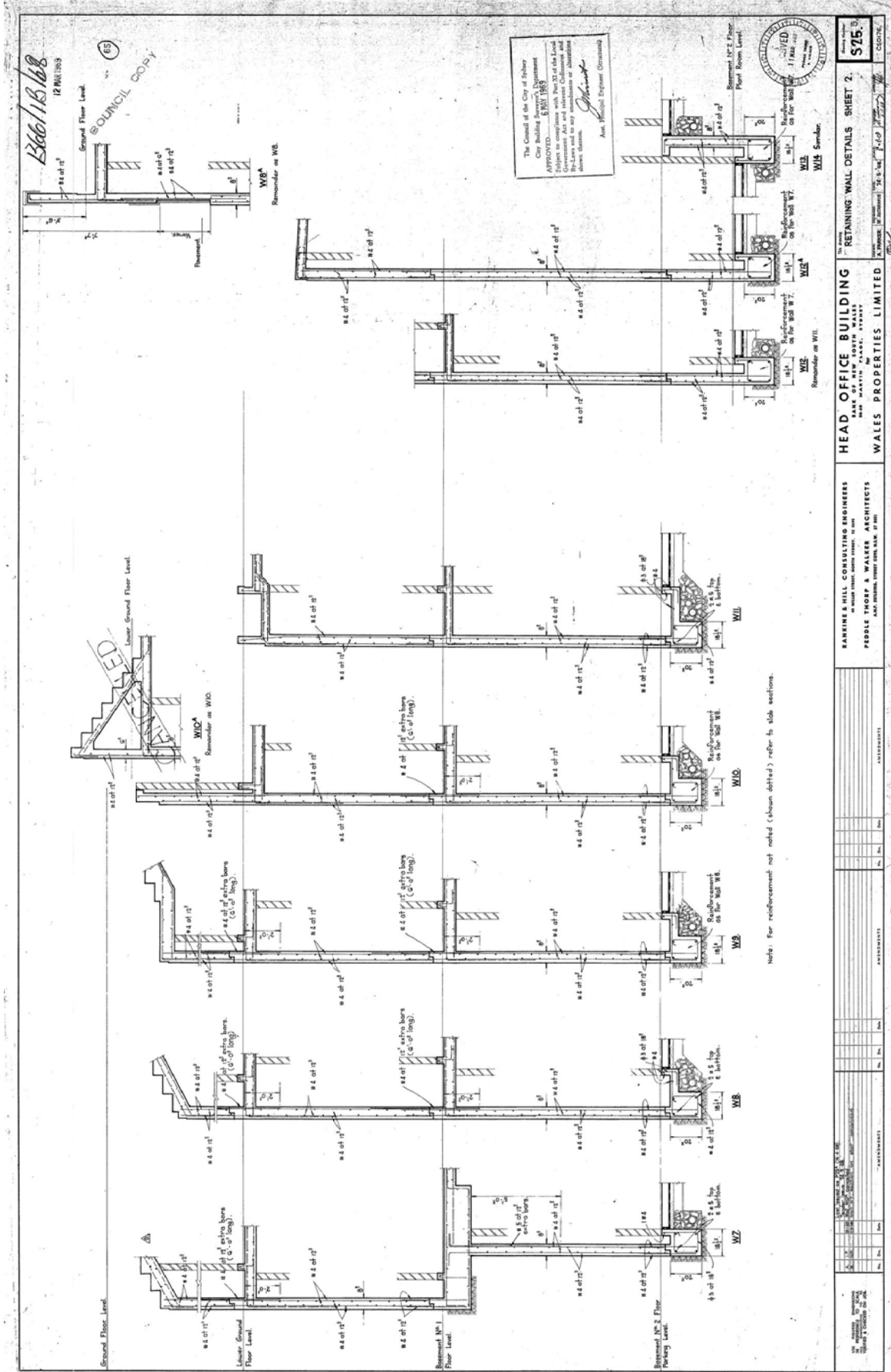

Figure 4 – Existing Retaining Wall Sections Sheet 2

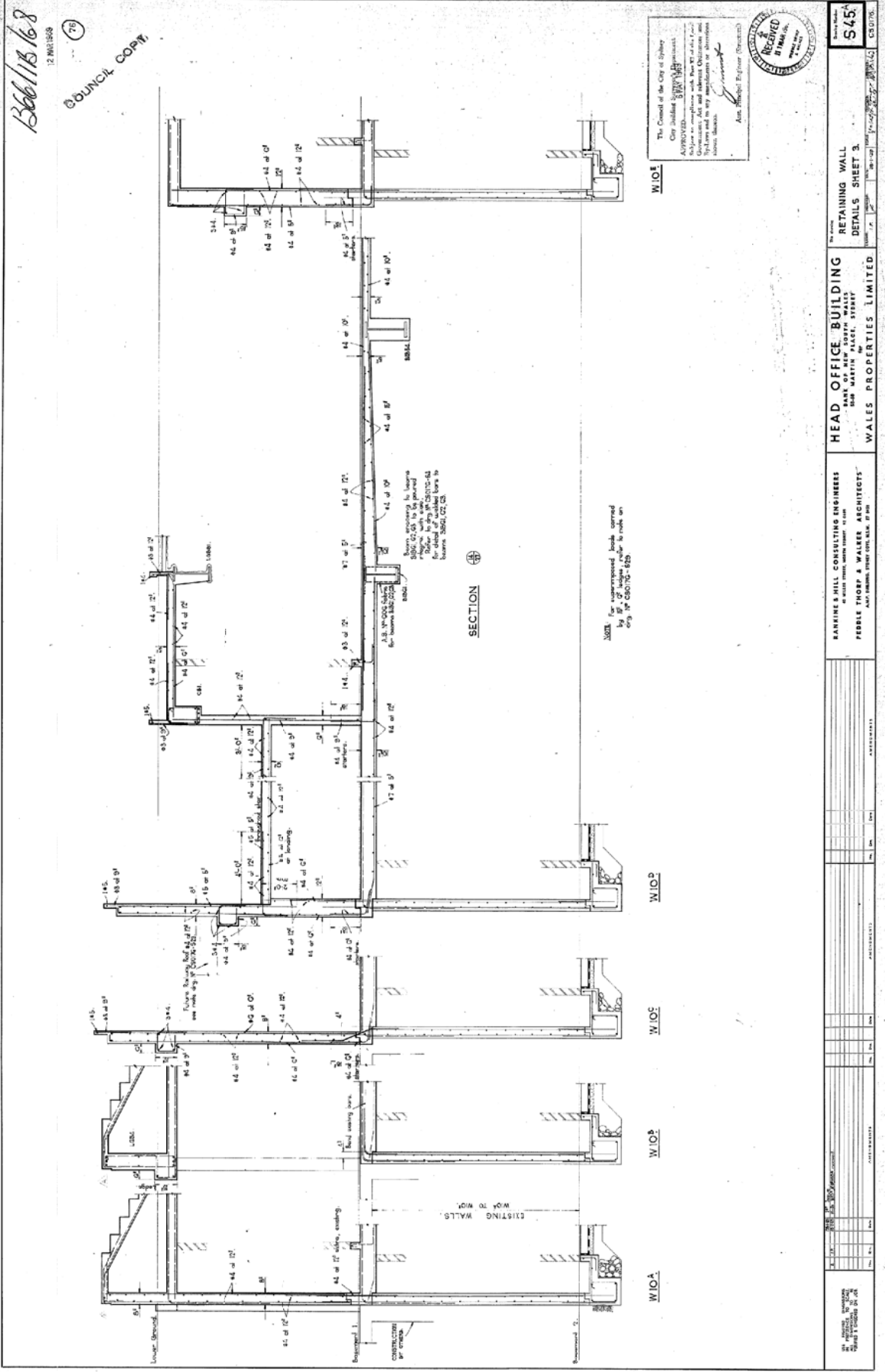

Figure 5 – Existing Retaining Wall Sections Sheet 3











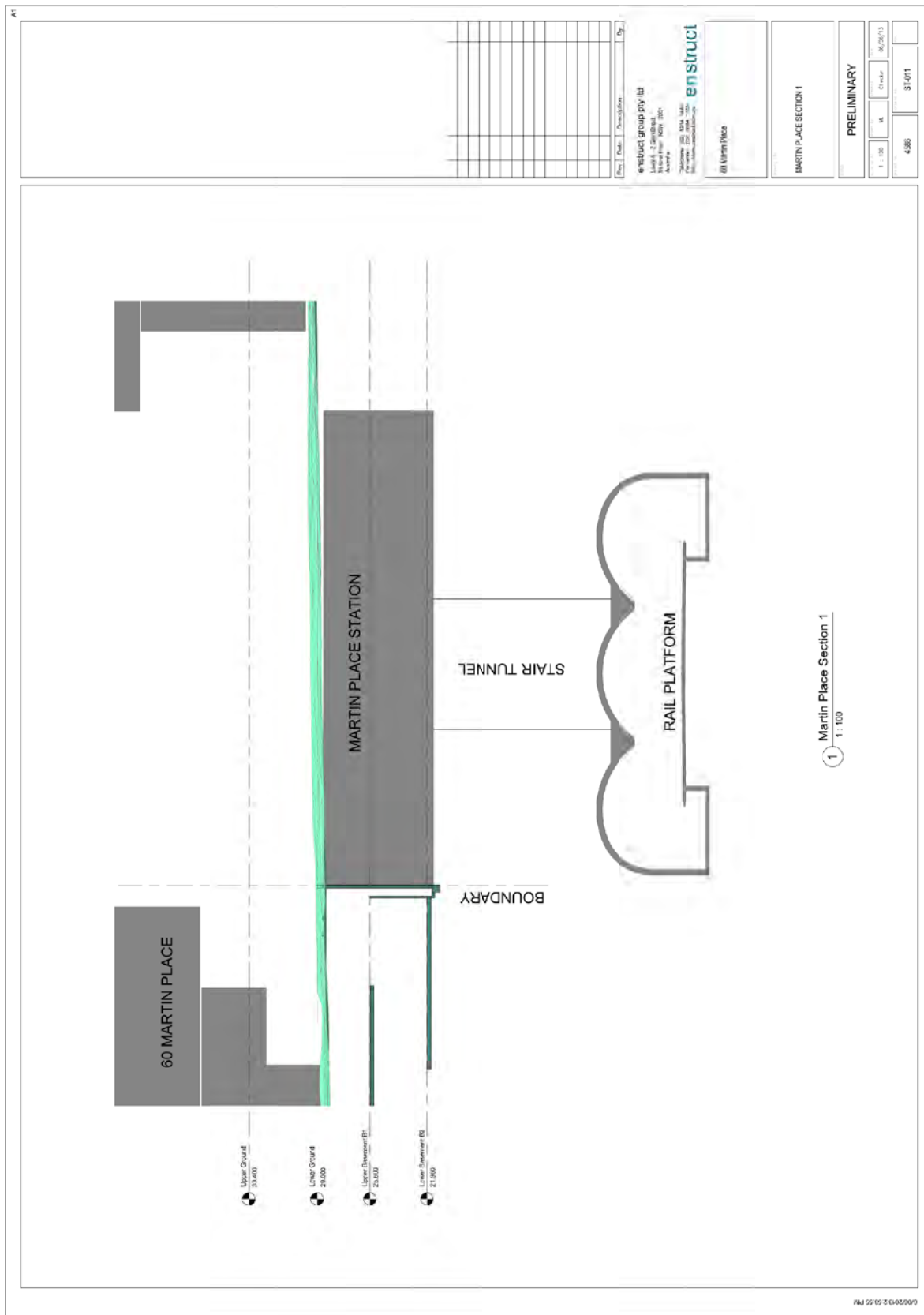

Figure 9 – Section through 60 Martin Place and Martin Place Station

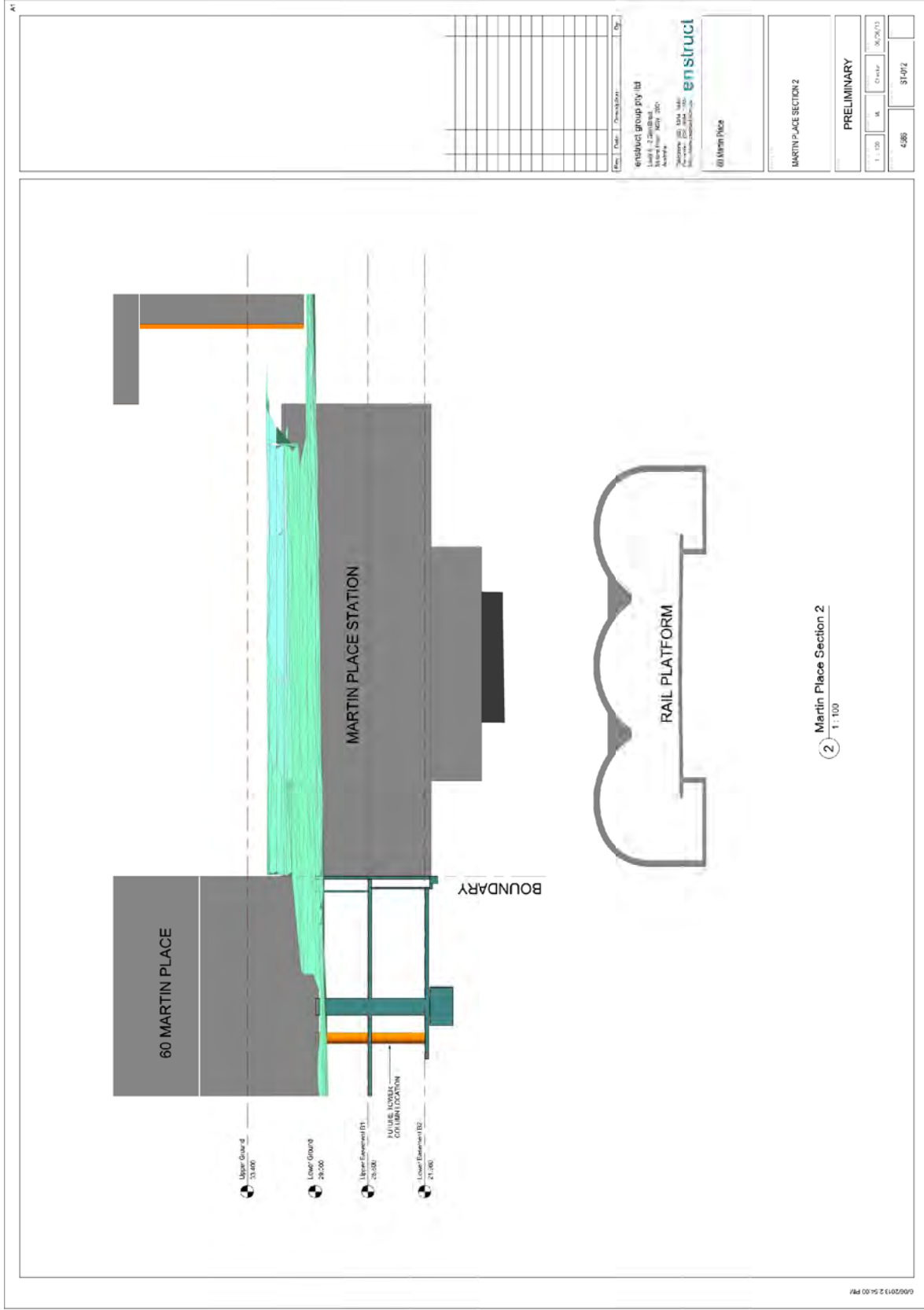

Figure 10 – Section through 60 Martin Place and Martin Place Station



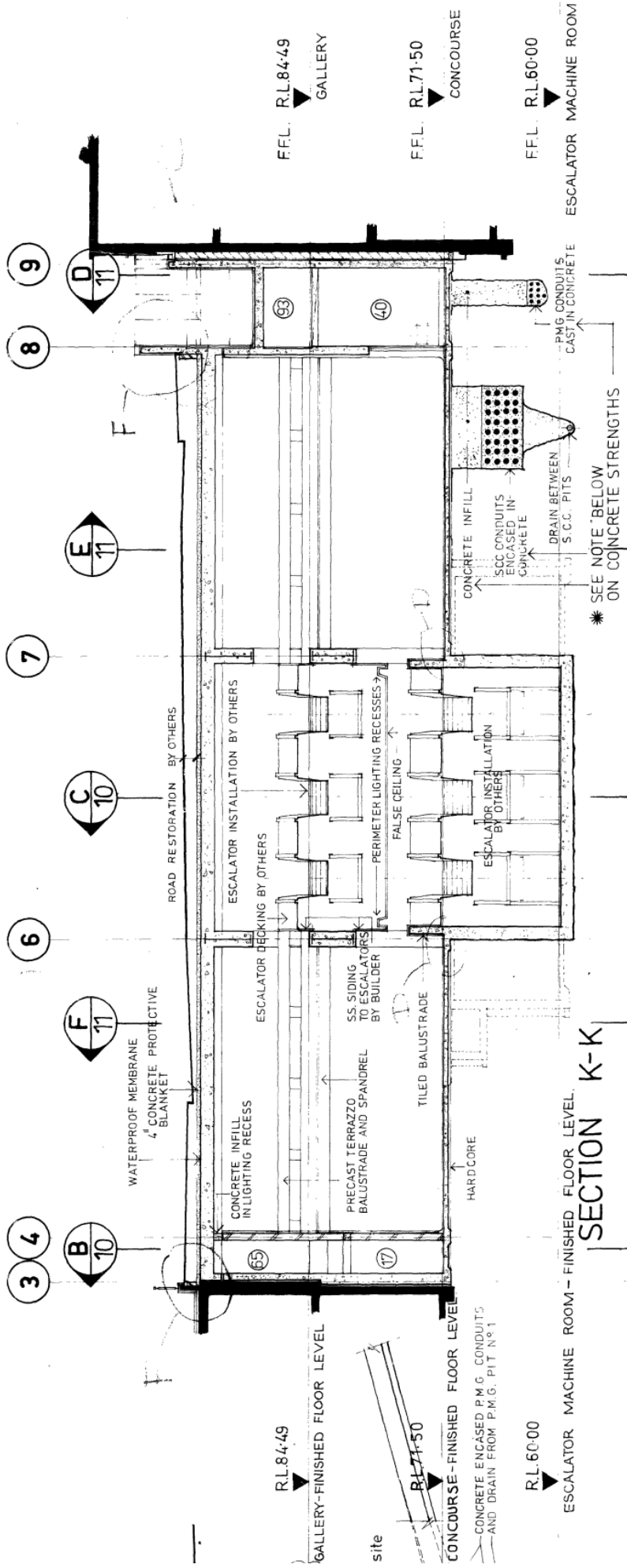

Figure 12 – Existing Section Through Martin Place Station and 60 Martin Place (section looking to the east)





## 4 RailCorp Infrastructure

### 4.1 City Circle Line

The existing drawings are dated in the late 1920s and describe three tunnels mined in rock adjacent to the site. The drawings shown in Figures 14 to 16 show set out information for the tunnels being of concrete arch construction.

### 4.2 Eastern Suburbs Rail Line

Construction of the Eastern suburbs line commenced in the late 1940's was abandoned with partial completion of Martin Place Station in 1952 and then recommenced in 1967, with completion in 1979. The existing drawings shown in Figures 17 & 18 show the extent of tunnel construction before and after construction of the existing 60 Martin Place structure.

### 4.3 Easements

Typically Railcorp establish easements and performance criteria for modern infrastructure to protect its assets from the effects of adjacent development, however with the age of the adjacent tunnels this information is not available in the form of a typical diagram and further information on these requirements should be requested of RailCorp.

In this case the key potential effects are:

- i. Basement excavation resulting in stress relief of the rock adjacent to the tunnel crowns.
- ii. Building load influence zones.
- iii. Demolition and construction methodology – vibration and acoustic control.

M.R.C.

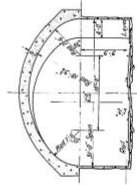
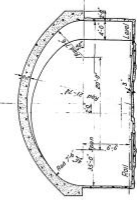
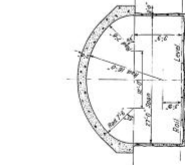
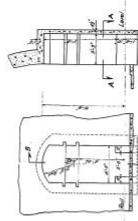
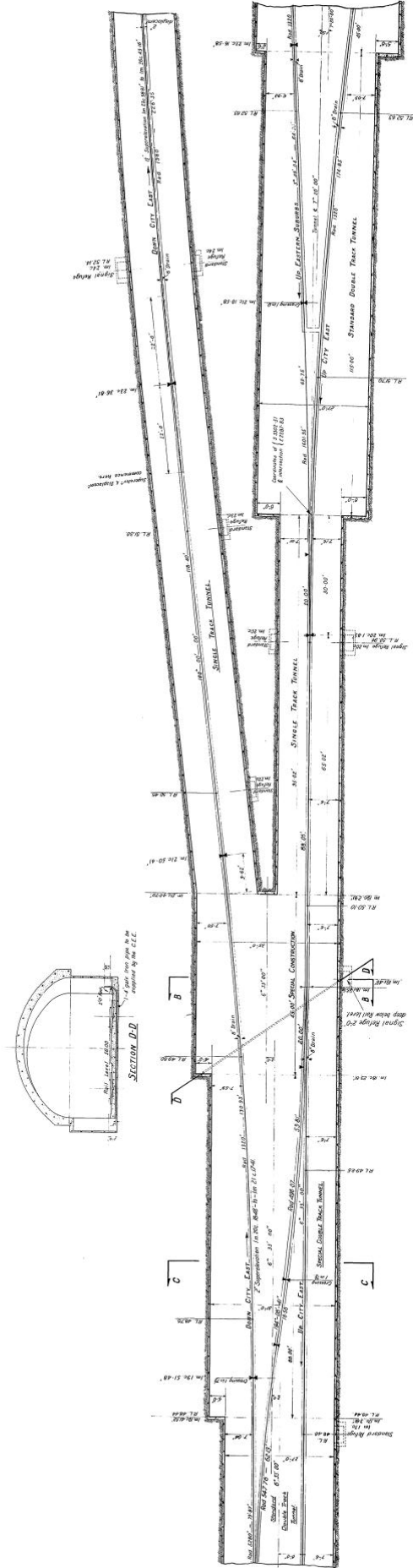

NOTE: In hard rock materials below springing to be excavated above to finished line and facing with concrete. The tunnel shall be lined with a single track tunnel to be 15' 0" track and in double track tunnel 24' 0" track. The concrete shall be 100% of cement, 1 1/2 parts of sand and 2 1/2 parts of gravel. The concrete shall be placed against the face of rock. The concrete shall be 100% of cement, 1 1/2 parts of sand and 2 1/2 parts of gravel. All levels shown are finished and are referred to Standard Datum.

Reference  
For Special Construction Detail of this Tunnel, see page 7.C.105  
for details of Standard

EDMUND CHURCHILL DRAWING STANDARDS BUREAU  
H. S. W. GOVERNMENT BUILDINGS  
**THE CITY RAILWAY**  
Special Construction under Macquarie Street  
North of Liverpool Street, Sydney  
Sheet No. 7.C.105

APPROVED  
P. J. C. (P. J. C. & Co.)  
P. J. C. & Co. (P. J. C. & Co.)

Figure 14 – City Circle Tunnel Part Plan and Sections

M.R.C.

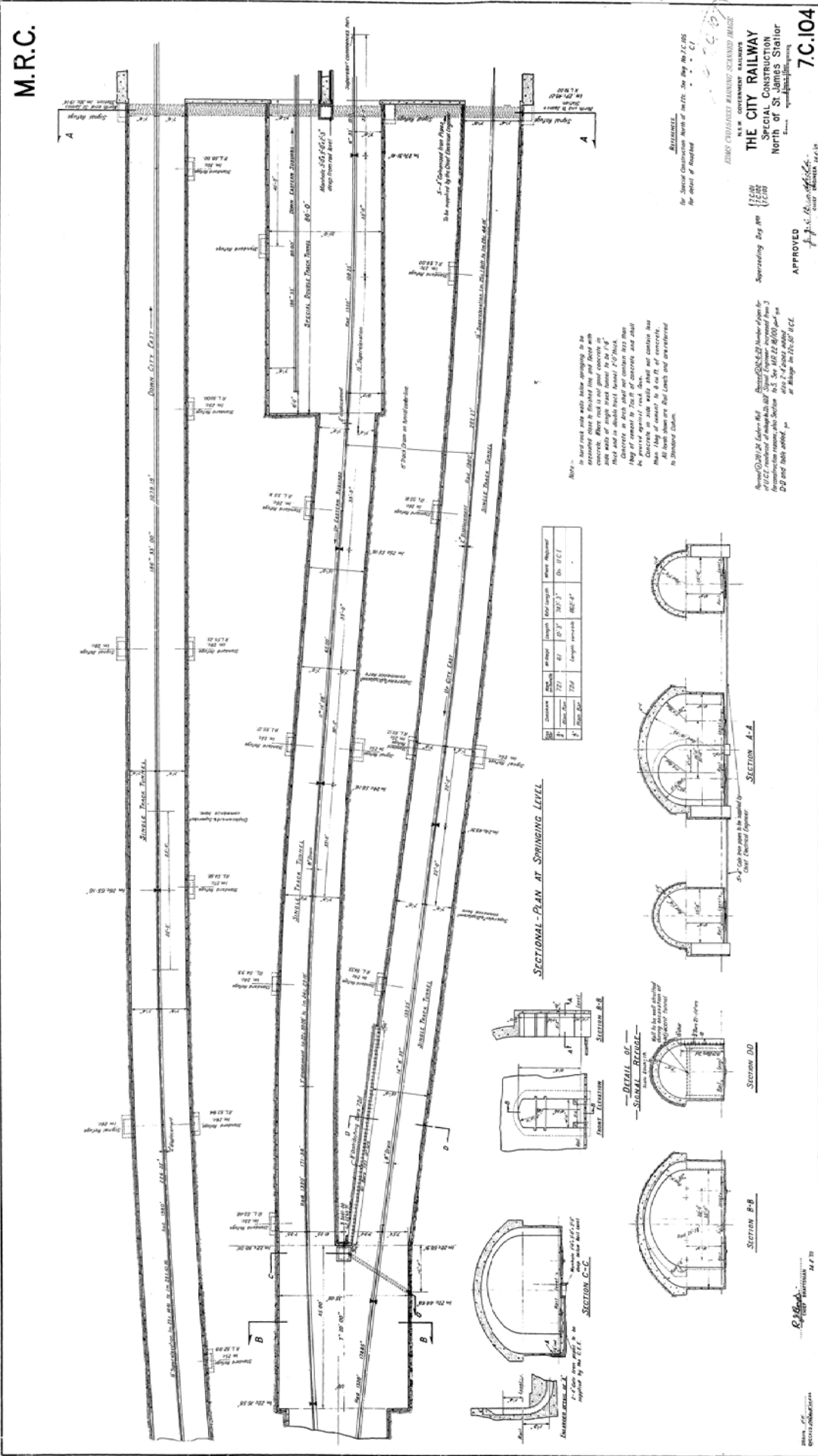

Figure 15 – City Circle Tunnel Part Plan and Sections

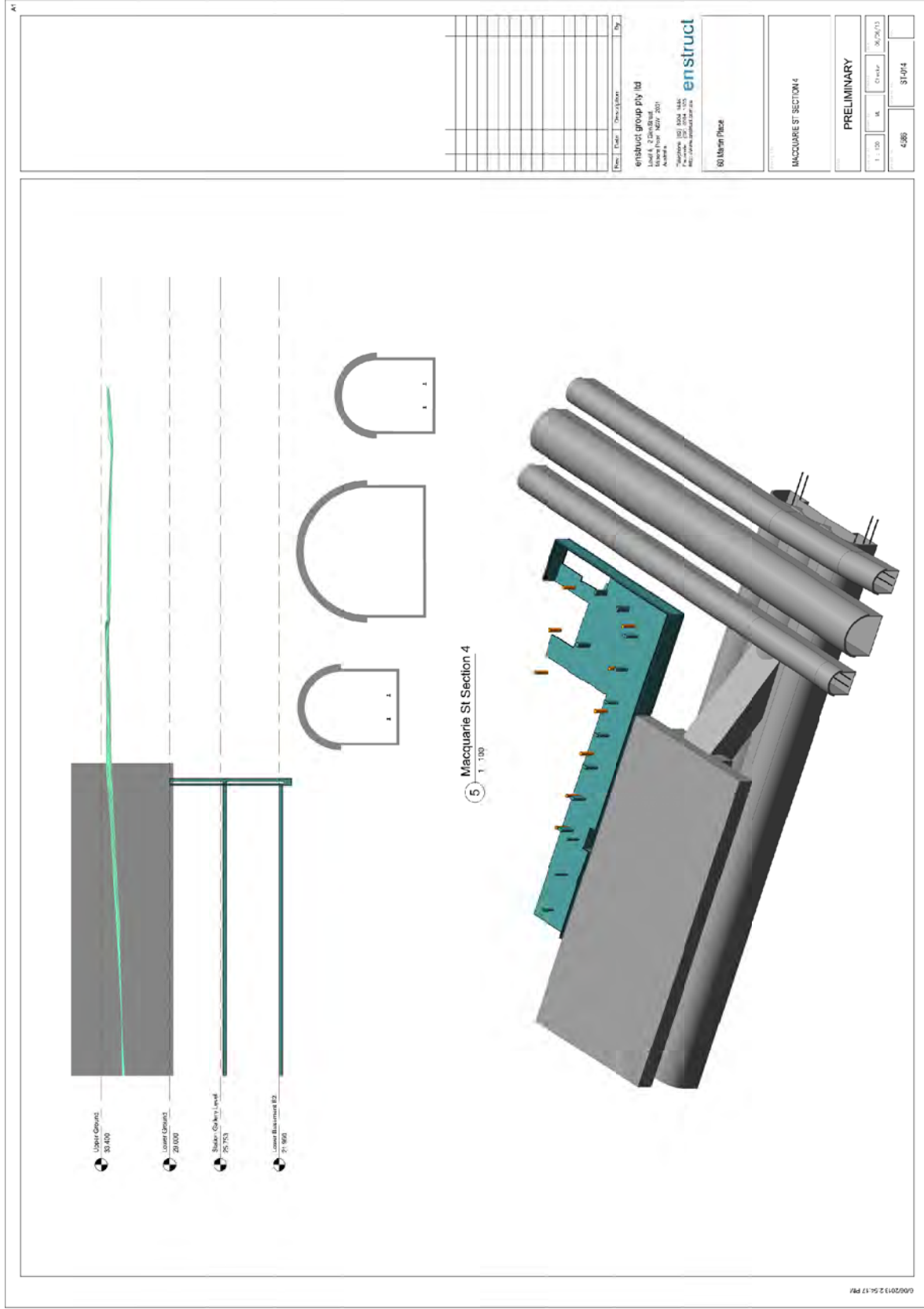

Figure 16 – City Circle Tunnel Part Plan and Sections







proceed using conventional construction techniques – the core will be jump formed, cast in situ columns and floor plates. It is expected that Phillip Street will be the primary construction access point, with the site served by two tower cranes, materials / man and formwork hoists.

## 5 Proposed Development

### 5.1 Basement

The existing 200 mm reinforced concrete perimeter walls will be retained to provide temporary perimeter restraint during demolition and construction, temporary ground anchors will be required to tie back these walls. The proposed development will contain multi-level post tensioned floor plates which will provide permanent lateral restraint to the perimeter retaining wall.

### 5.2 Foundation

A detailed geotechnical investigation of the site will be carried out prior to demolition. It is expected that the primary structural elements namely the tower columns and the core will be supported on pad foundations, with allowable bearing pressures in the order of 5MPa. Depending on detailed analysis, it is possible that the core may require permanent vertical ground anchors to achieve lateral stability.

### 5.3 Superstructure

A schematic building design has been developed to prove up the Stage 1 DA. The building contains some 28 stories of typically 1250 square metres net lettable area. The building core is located in the north western corner of the floor plate. The building also has a low level podium. The expected construction of the proposed building is a concrete framed building with post tensioned floor plates, reinforced concrete columns and reinforced concrete core providing the buildings lateral capacity. Refer to Figures 19 & 20 below for typical low rise framing plan of the proposed development.

### 5.4 Demolition Methodology

Martin Place Station currently contains a stair egress via the south western corner of 60 Martin Place, this arrangement will need to be reconfigured prior to any works on site.

The superstructure is a regular steel frame which will be well suited to conventional demolition techniques. Temporary ground anchors will be installed to support the perimeter retaining walls. It is expected that demolition / construction traffic will be directed along Phillip Street. Prior to demolition dilapidation surveys of adjacent property will be carried out and where necessary vibration monitoring carried out to control demolition processes.

### 5.5 Construction Methodology

The proposed development does not extend beyond the existing basement excavation, and as such only detailed foundation excavation will be required. The superstructure will then

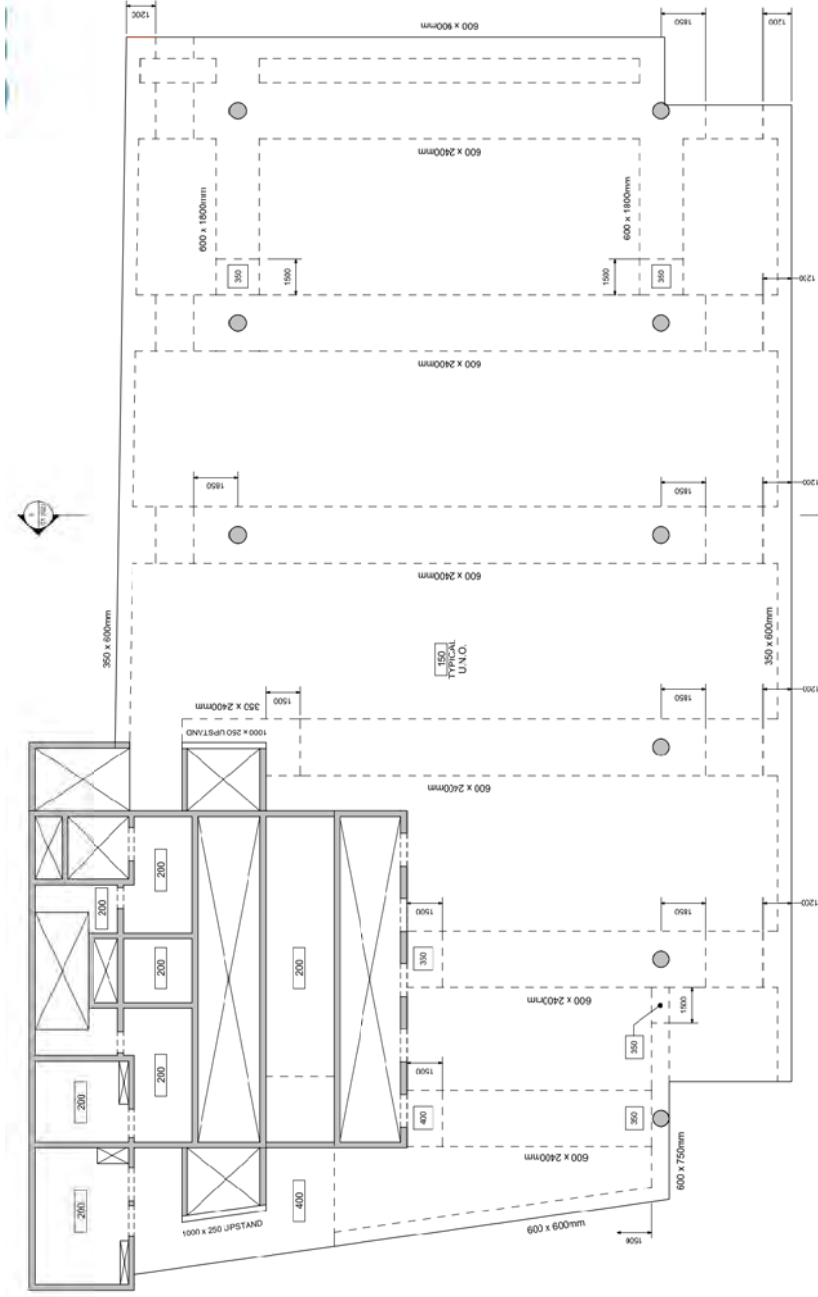

TYPICAL LOW RISE GENERAL ARRANGEMENT

SCALE = 1:100 (A1 AT)

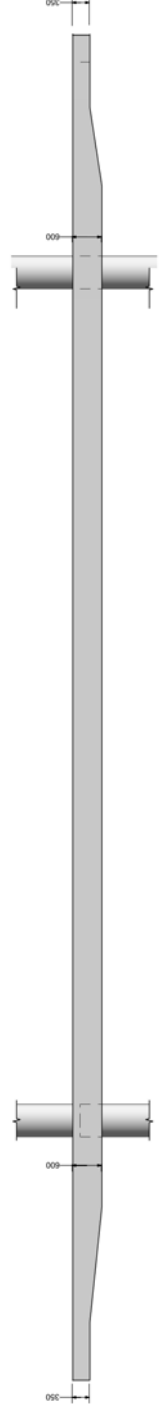

SECTION 1-1  
SCALE 1:100

Figure 19 – Typical Low Rise Framing Plan of Proposed Development

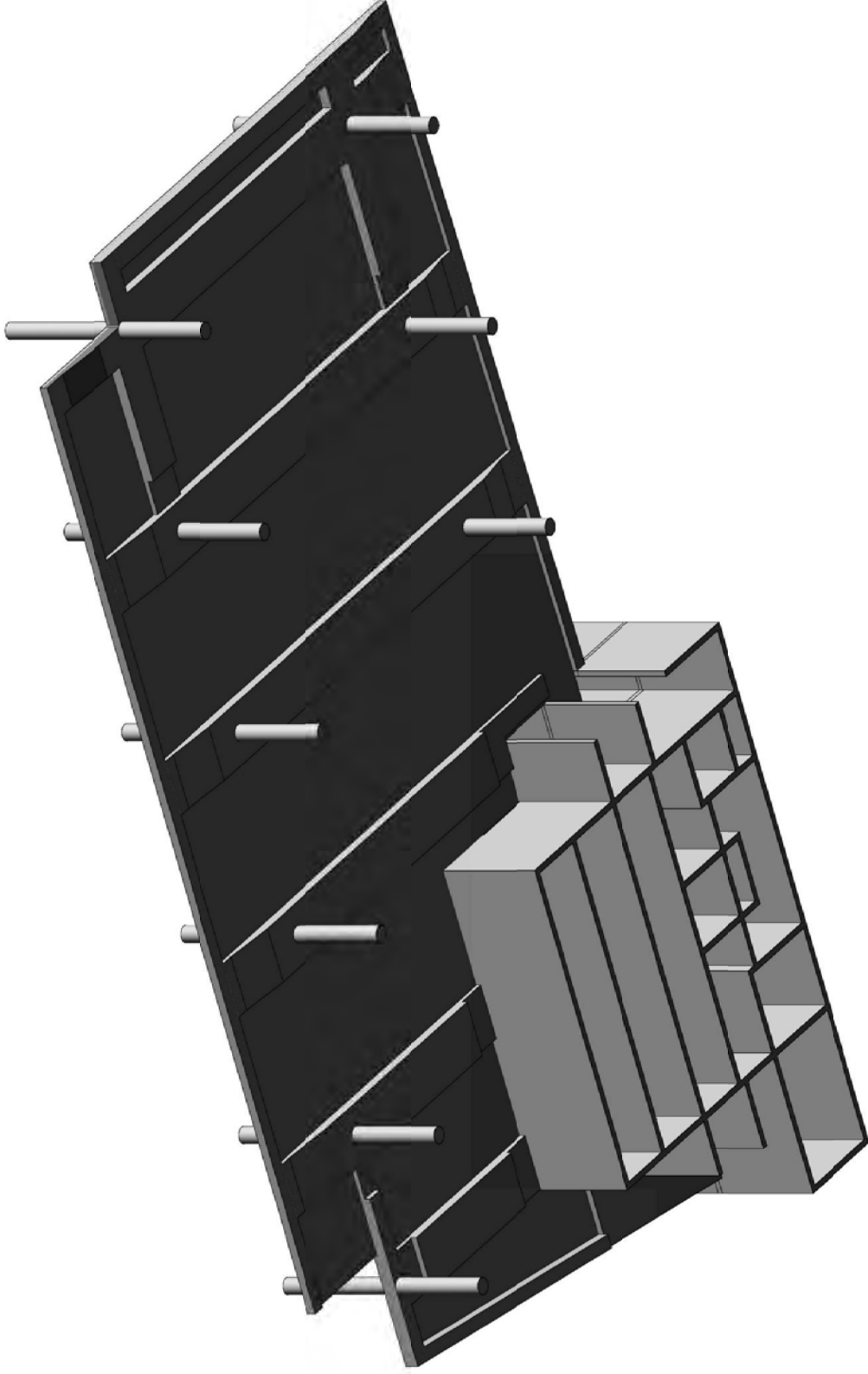

TYPICAL LOW RISE ISOMETRIC

Figure 20 – Typical Low Rise Isometric of Proposed Development



## 6 Study

### 6.1 RailCorp Briefing

On 2 May 2013, Enstruct and Investa met with Railcorp (minutes attached in Appendix B) to provide an overview of the proposed development and agree ongoing deliverables to enable in principle support by Railcorp for the Stage 1 Development Application. A commitment was made to prepare a Design Report for distribution to Railcorp and inclusion in the Stage 1 DA.

### 6.2 Existing Drawings

Railcorp have provided enstruct with soft copies of all drawings held relating to both the City Circle Line and the Eastern Suburbs Line – whilst the Snowy Mountains Hydro Electric Authority most likely will hold As-Builts for the Eastern Suburbs Line, it is likely that no other drawings for the City Circle Line will be accessible.

The City Circle Line drawings (late 1920s) provide adequate set out and dimensional information for the purposes of this and future studies. We have consulted RailCorp's Principal Surveyor, Ian Jones, during this process.

The Eastern Suburbs Line drawings contain fully dimensioned and detailed architectural and structural drawings.

### 6.3 3D Modelling

Using the Railcorp existing drawings, a 3D computer model (Revit) of the proposed development and the adjacent Railcorp infrastructure has been developed to support this study and the Stage 1 DA. This model provides a very accurate spacial description as the basis for further design development and analysis. Refer to Figure 21 for an illustration of the model that has been developed.

### 6.4 Engineering Analysis

#### 6.4.1 Geotechnical Desktop Study

Enstruct has commissioned Parsons Brinckerhoff to provide specialist advice with respect to site geology and rock mechanics and we attach a copy of their report in Appendix A. The Parsons Brinckerhoff report identifies the existing site conditions as follows.

*Based on published and Parsons Brinckerhoff's archive geological and geotechnical information and local knowledge of conditions in the Martin Place area the site is underlain by a surface layer of fill and residual soil overlying Hawkesbury sandstone at shallow depth. The Martin Place station excavations, together with the excavation and exploration for the Bank*

*sites, show that, apart from a little surface fill, the station and concourse is located within Hawkesbury sandstone (Dept. of Railways, 1969). Along the north boundary (126 Phillip Street), drawings show Class IV sandstone (based on the classification system in Pells et al, 1998) inferred below approximately RL 23.2m. The site is partially located in the Martin Place joint swarm. The Martin Place joint swarm has a NNE strike and has been recorded elsewhere to contain closely spaced jointing, and zones of crushing and shearing. While containing sub-vertical jointing, the joint swarm is further inferred to be associated with low angle thrust faulting. Evidence of jointing observed in mapping of the basement rock face is shown in Figure 2. We consider it reasonable to assume that the sandstone outside the joint swarm area is likely to be of Class III or better at basement level. Shale lenses and shale breccia zones may be present within the sandstone.*

#### 6.4.2 Structural Analysis

A structural design has been advanced to a stage to allow determination of all the primary structural elements ie vertical structure, typical floor plates, core and foundation. A detailed vertical and lateral analysis has been carried out to size members and also provide foundation reactions relevant to this study. For this building configuration we would expect that these results will be within 10 % of final figures.

#### 6.4.3 Development/Infrastructure Interaction

60 Martin Place lies within the zones of influence of the tunnels and the cavern. The demolition of the existing building and the construction of the new building will have some effect on the distribution of stresses in the rock adjacent to the tunnels and cavern. Analytical tools ('finite element analysis') are used to model and evaluate these effects.

In this case, the primary effect will be the removal of the existing column loads adjacent to the tunnels and then the effect of the application of the new tower column loads. These effects are a function of the column load and its proximity to the tunnels. Refer to Figures 22 & 23 for sections through the development site and the City Circle and Eastern Suburbs rail lines.

Based on the column load and the proposed building geometry the Parsons Brinckerhoff report identifies that minor movements of the tunnel may be experienced during the unloading and loading caused by the demolition and construction of the proposed development however it is expected that with the configuration this will not compromise the existing tunnels which will require further validation via numerical modelling as the development progresses to the next stage. For a different building configuration ie column location and load a separate analysis would be required.

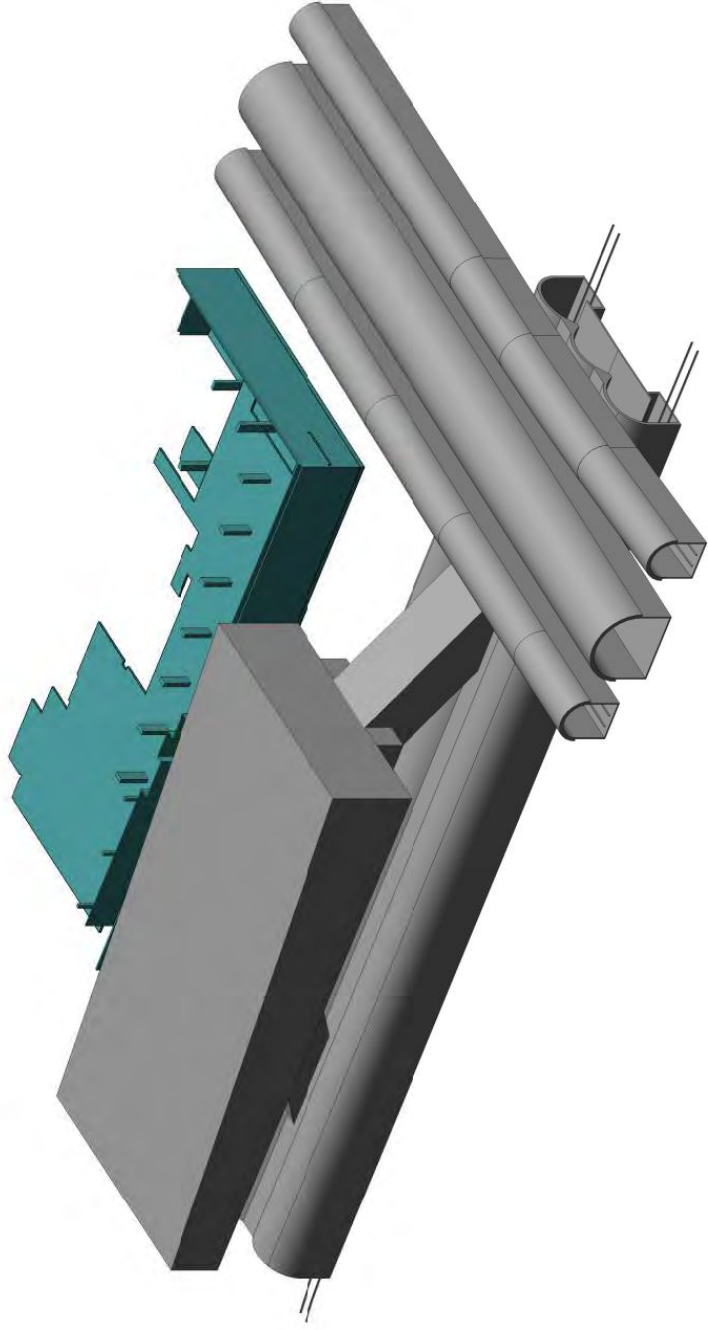
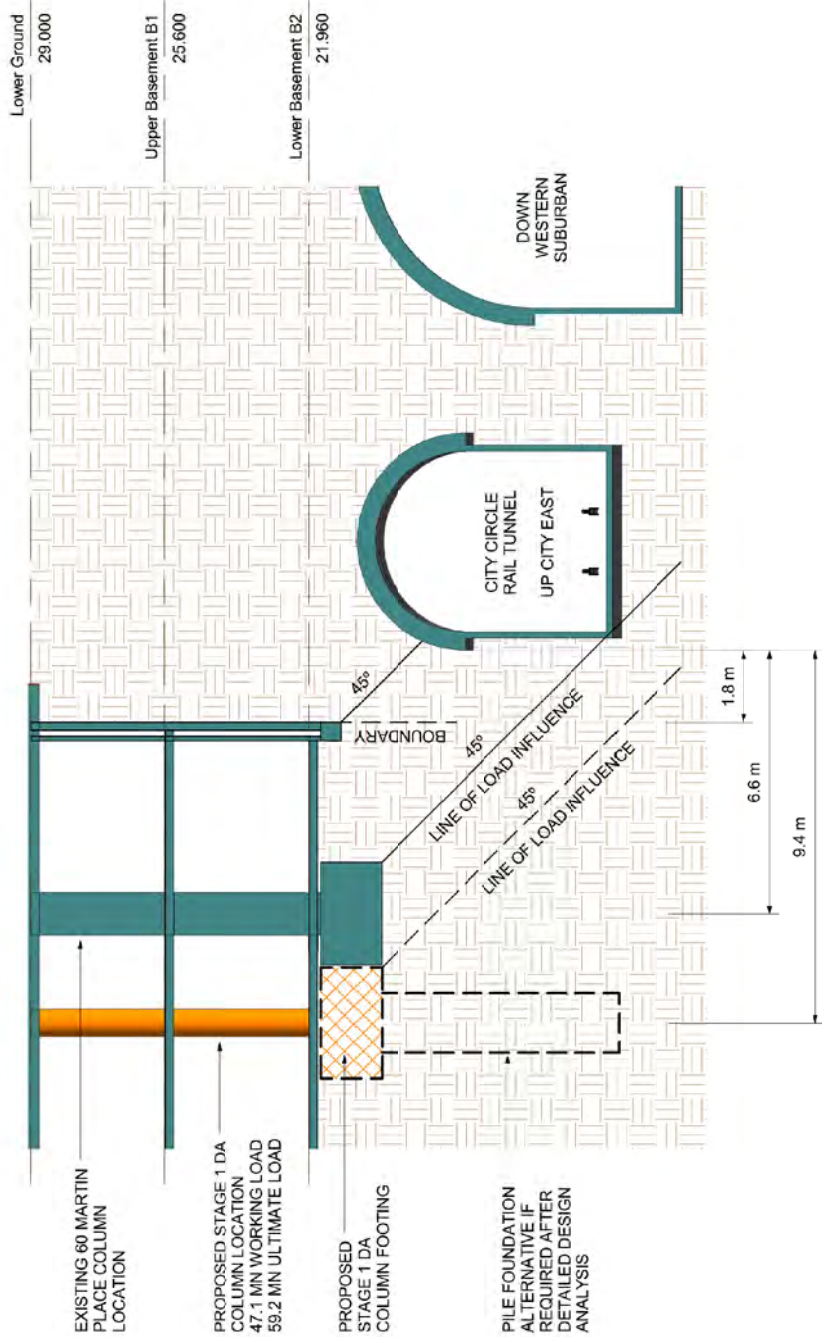
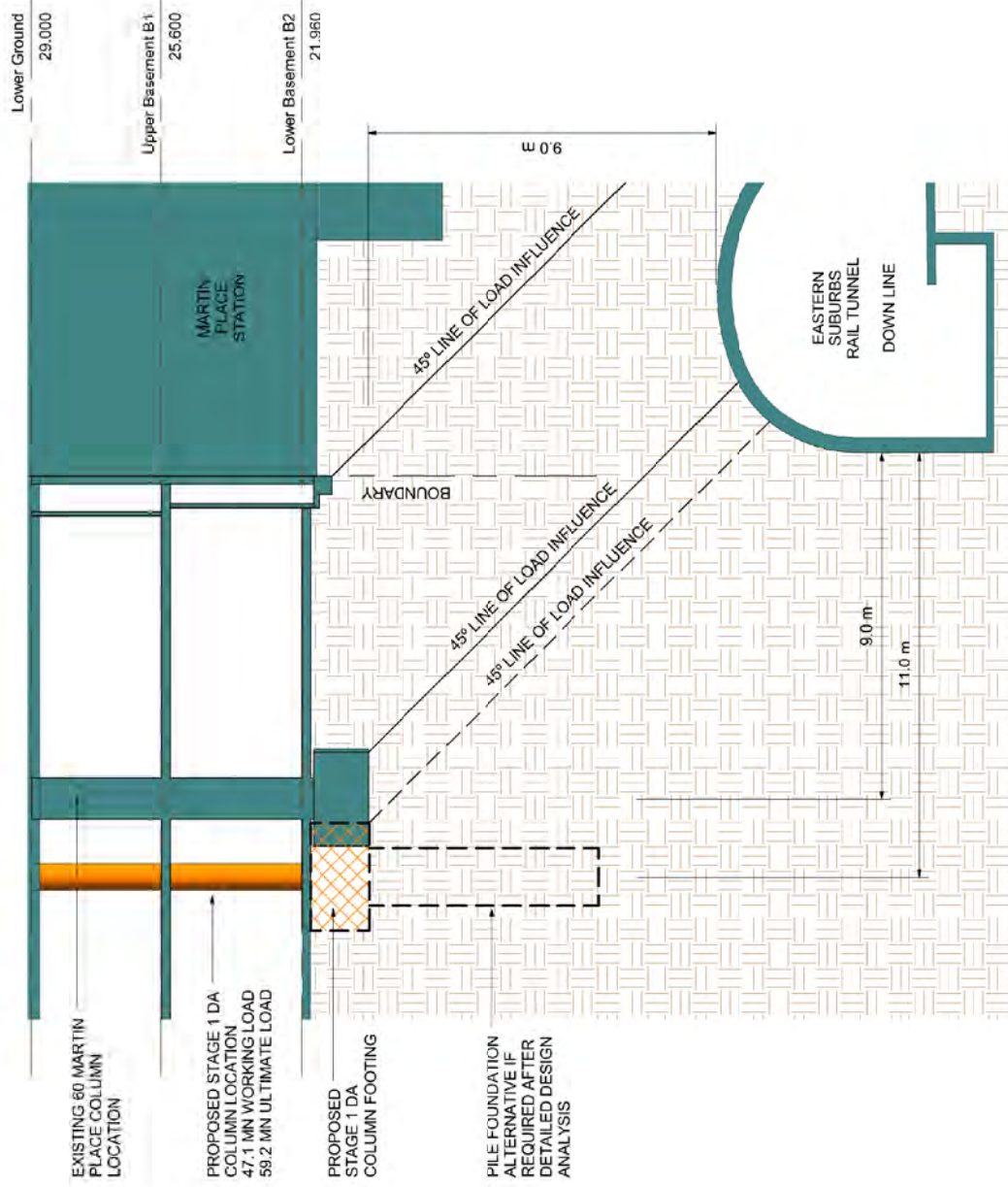

Figure 21 – 3D Image of Existing 60 Martin Place Basement and RailCorp Infrastructure



MACQUARIE ST SECTION

Figure 22 – Section through Development Site and City Circle Rail Line on Macquarie St



MARTIN PLACE SECTION

Figure 23 – Section through Development Site and Eastern Suburbs Rail Line on Martin Place

## 7 Project Delivery

### 7.1 Process

Investa Property Group and Gwynvill Group will shortly submit an LEP Amendment and Stage 1 Development Application for 60 Martin Place, Sydney, which will contain this design report. The approval of this application, which will include an in principle support from RailCorp, will then allow the client to conduct a Design Competition for the project.

This document will form part of the brief for the design competition and will advise the assessment of the design competition. The successful competition submission will then prepare a Stage 2 Development Application, whose approval would allow final documentation and delivery of the building.

This design report will be reworked to match the Stage 2 Development Application containing the successful design competition. This will also be a more rigorous report supported by detailed geotechnical information and advanced structure/rock mechanics analysis. The report will be updated to reflect construction documents as the basis for the Building Approval. Finally, during construction an 'As-Built' report will be submitted.

### 7.2 Studies and Reporting to RailCorp

In summary, it is proposed the following submissions will be made to RailCorp:

- i. Stage 1 DA Design Report;
- ii. Stage 2 DA Design Report – Containing detailed geotechnical investigation;
- iii. For Construction Design Report – Reflecting final design;
- iv. Construction Phase – Reporting site inspections of in-situ conditions and As-Builts.





Parsons Brinckerhoff Australia Pty Limited

ABN 80 078 004 798

15 June 2013

Ross Clarke  
Enstruct Group Pty Ltd  
Level 4, 2 Glen Street,  
Milsons Point NSW 2061

Level 27 Ernst & Young Centre  
680 George Street, Sydney NSW 2000  
GPO Box 5394  
Sydney NSW 2001  
Australia  
Tel: +61 2 9272 5100  
Fax: +61 2 9272 5101  
Email: sydney@pb.com.au

[www.pbworld.com](http://www.pbworld.com)

Certified to ISO 9001, ISO 14001, AS/NZS 4801  
A GRI Rating: Sustainability Report 2011

Our ref: 2189721A-TPT-LTR-004A RevC

By email  
Ross.Clarke@enstruct.com.au

Dear Ross

## **60 Martin Place, Sydney Assessment of impact of proposed Investa redevelopment on rail Infrastructure**

### **1. Introduction**

This letter report presents a preliminary assessment of potential geotechnical related impacts associated with the proposed redevelopment at 60 Martin Place, Sydney on RailCorp's rail infrastructure (Eastern Suburbs and Illawarra line (ESIL), Martin Place station (MPS) and City Circle line (CCL)).

The purpose of this report is to:

- Examine possible impacts of the multistorey redevelopment on the existing rail infrastructure
- Assess whether demolition/construction associated with the proposed redevelopment will adversely affect the existing underground rail infrastructure
- Provide an overview of geotechnical aspects of the proposed development to enable in principle support by RailCorp for the Stage 1 Development Application
- Obtain Stage 1 Development Application (DA) approval.

This preliminary report concludes that it is reasonable to expect that demolition of the existing building and construction of the proposed building can proceed without adversely affecting RailCorp underground infrastructure. Further analysis will be necessary to assess risk mitigation measures to ensure impacts of the development are acceptable to RailCorp.

### **2. Available information**

This assessment is based on the following available data and supporting information:

- Craig & Rhodes detail survey over Lot 1 D.P. 221322, No. 60 Martin Place, Sydney Drawings 210-12G T01 [01] – 01 to 04, January 2013
- Enstruct preliminary drawings ST-001 (Lower Basement General Arrangement Plan and Section), ST-011 to ST-014 (Martin Place Section 1 to 3 and Macquarie Street Section 4), 2013.

- Various RailCorp plans and section drawings for the City Circle line, Martin Place station, Eastern Suburbs railway, 1917 to 1978.
- Geological information obtained from exploratory drilling for the Reserve Bank building and the former open-cut for the Bank of New South Wales building, both of which are adjacent to the railway station site (Dept. of Railways, 1969).
- Enstruct detailed 3D computer model showing the existing 60 Martin Place development and RailCorp infrastructure.
- Parsons Brinckerhoff's archive geotechnical information.

### 3. Proposed development

The proposed development includes a 30-storey office tower with a two-level basement up to 11m deep (to approximately RL 22m), the same level as the existing development. The proposed development will not extend the existing basement and will replace the existing superstructure with a building of similar form. Existing basement walls will be retained thus maintaining separation between the construction site and the station.

The ground surface at street level falls from east to west from approximately RL 33m on Macquarie Street to RL 29m along the southern Martin Place/Phillip Street property boundary (see Figure 1). The site is adjacent to two pieces of RailCorp infrastructure: the City Circle line to the east and the Eastern Suburbs and Illawara rail line (Martin Place Station Cavern and adjoining tunnels) to the south. Refer to enstruct drawings for the plan and sections.

The horizontal distance between the edge of the proposed redevelopment tower footings and the nearest edge of the City Circle Line tunnels and Martin Place Station is 9m and 7.3m respectively. Enstruct has advised that future individual tower column loads are of the order of 47.1MN (working/ serviceability) and 59.2MN (ultimate).

#### 3.1 RailCorp infrastructure

Based on available information, including Department of Railways NSW drawings, Australian Railway Historical Society bulletins, and Edwards and Morgan (1991), the sequence of the existing developments has been assumed to be as follows:

1. City Circle line contains three tunnels constructed in the 1920s. The section from Wynyard to St James, adjacent to the development was opened in 1956, forming the loop we have today. Drawings dated 1923, photos dated 1954 (see Photo 3.1), and borehole information in Macquarie Street, indicate the tunnels were mined in rock, and are of concrete arch/ sidewalls construction
2. Eastern Suburbs line tunnels partially mined and lined in 1951/ 1952. Partial completion of Martin Place station
3. 60 Martin Place development constructed late 1960s and opened in 1971
4. Eastern Suburbs line tunnel construction recommenced in 1967 and opened in 1979
5. Martin Place station opened on 23 June 1979 as part of the inauguration of the Eastern Suburbs Railway (ESR) line.

In both cases the tunnels appear to have been mined in sandstone. The Martin Place station box was constructed using an open-cut excavation. The underlying Martin Place station cavern and ramps were partly excavated by mining methods, consisting of pilot drives along the station, connected by rises and crosscuts. A shaft leads from the station to the road surface of Martin Place, and the pilot drives are connected to the tunnels from the Domain Portal by small access tunnels. Geological sections along the line of crosscuts are shown in Figure 2. The driller's logs of the holes at the Reserve Bank site, and a geological log of the part of the Bank of New South Wales open-cut which was adjacent to the station concourse, are shown in Figure 2.

**Photo 3.1 - Views showing methods adopted in tunnelling work near Martin Place station in 1954 (source PTC of NSW archives)**



### 3.2 Previous investigations and expected subsurface conditions

Based on published and Parsons Brinckerhoff's archive geological and geotechnical information and local knowledge of conditions in the Martin Place area the site is underlain by a surface layer of fill and residual soil overlying Hawkesbury sandstone at shallow depth. The Martin Place station excavations, together with the excavation and exploration for the Bank sites, show that, apart from a little surface fill, the station and concourse is located within Hawkesbury sandstone (Dept. of Railways, 1969). Along the north boundary (126 Phillip Street), drawings show Class IV sandstone (based on the classification system in Pells et al, 1998) inferred below approximately RL 23.2m.

The site is partially located in the Martin Place joint swarm. The Martin Place joint swarm has a NNE strike and has been recorded elsewhere to contain closely spaced jointing, and zones of crushing and shearing. While containing sub-vertical jointing, the joint swarm is further inferred to be associated with low angle thrust faulting. Evidence of jointing observed in mapping of the basement rock face is shown in Figure 2.

We consider it reasonable to assume that the sandstone outside the joint swarm area is likely to be of Class III or better at basement level. Shale lenses and shale breccia zones may be present within the sandstone.

Exploratory borehole locations and geological conditions are shown in Figure 1.

### 3.3 RailCorp criteria

Investa, Parsons Brinckerhoff and Enstruct met with RailCorp property (Land Use and Planning) to establish likely RailCorp criteria for the redevelopment on 2 May 2013. No specific requirements, advice on underground infrastructure protection guidelines/ rail protection reserves, or concerns were advised by RailCorp.

## 4. Proposed tower column footings

We assess that the majority of the footings for the proposed development will be located in competent sandstone below RL 21.9m. Based on classifications provided in Pells et al (1998), this zone outside the joint swarm area may be classified overall as Class III sandstone. Thus, provided the total thickness of crushed zones and clay seams, within 1.5 times the minimum dimension of a footing, is less than 5%, and the effects on adjacent infrastructure are acceptable, the footing may be designed for an allowable end bearing pressure of half the unconfined compressive strength of the rock substance. For concept design we recommend the tower columns and core be supported on pad footings with maximum allowable end bearing pressure of 5 MPa.

The design end bearing pressure given above would have to be reduced in areas of less competent rock or taken to a level where the 5 MPa value is again appropriate. At present the plan extent of this weaker and more compressible zone is not known.

## 5. Interaction between developments

There are risks to the existing underground infrastructure associated with demolition and construction of the proposed redevelopment. Stress relief in the ground and tunnels due to demolition of the existing structure and subsequent redevelopment loading may result in ground movement which could potentially cause detrimental effects on the existing underground infrastructure.

### 5.1 City Circle line

Review of RailCorp drawings and structural drawings indicates that the design of the existing building has generally transferred the influence zone of the column load down to the invert of the City Circle line tunnels (see Figure 3). Demolition of the existing structure will result in unloading and stress relief which could potentially generate upward displacement and cracking in the tunnels. Since the existing City Circle line tunnels have experienced loading due to the existing development we assess the unloading would partially reverse effects of initial loading. Similar effects were observed on the Regent Place (former Genting Centre) site at Town Hall station where demolition and subsequent development took place within 3m of existing rail tunnels (Hewitt et al, 1999) without compromising structural integrity of underground infrastructure.

Future foundation pad loading may also cause cracking in the tunnels. Cracking generated by future pad loading could be overcome by the use of sleeved piles which could transfer load below the invert level of the tunnels.



## **5.2 Eastern Suburbs & Illawarra lines and Martin Place station**

The Eastern Suburbs line tunnels are located below the City Circle line tunnels and likely within the zone of influence of the existing foundation pad loading. Therefore minor cracking due to stress relief effects from demolition could be generated by the unloading.

The roof of Martin Place station and rail platform cavern at the lower level is supported by rock bolts and concrete lining. It is also possible that unloading due to demolition may affect integrity of the roof support to the rail platform cavern (see Figure 4). At this stage it appears the separation between the rail platform cavern and the existing and proposed footings is sufficient to not have significant adverse effects.

## **6. Recommended work**

In the event there are issues to be addressed with respect to the existing underground infrastructure, we anticipate numerical modelling will be required to assess the impact on the existing tunnel/station structures of the excavation and building construction. The approach to the calculation of deformations and effects on infrastructure will be governed by the need to predict the stresses, movements and distortion of the existing tunnels/station.

If an outcome of the modelling is that the calculated deformations and distortions of the tunnel/station are unacceptable, further work is likely to be required to address areas of risk or further demonstrate that tunnel/station movements are within acceptable limits. This modelling may need to consider a range of input variables to account for sensitivity to such variables from construction configuration, initial stress conditions, ground stiffness, presence of joints, tunnel lining, requirements to avoid transfer of footing/pile loads to the tunnel, rock levels, interaction between Eastern Suburbs and Illawarra line, Martin Place station and City Circle line, and building loads.

An instrumentation and monitoring program may be required to measure ground movements and stresses between the proposed redevelopment and underground infrastructure prior to and during 60 Martin Place demolition and development. The monitoring systems should be installed prior to demolition and should measure internal ground movements including lateral bedding plane shear and bedding plane dilation, and tunnel sidewall convergence.

## **7. Conclusions and recommendations**

Based on available information, the following conclusions and recommendations are made:

- It is reasonable to expect that demolition of the existing building and construction of the proposed building can proceed without adversely affecting RailCorp infrastructure. Further analysis will be necessary to assess risk mitigation measures to ensure impacts of the development are acceptable to RailCorp.
- It is reasonable to expect that a separation of about two tunnel diameters (15m) between the existing basement and the tunnels is sufficient not to have significant effects on the existing RailCorp tunnels.
- Demolition at 60 Martin Place can be expected to result in minor changes to existing ground stress, and deformation in the ground around the existing tunnels and station. These effects are not expected to adversely impact the future construction of the proposed redevelopment at 60 Martin Place.

- The assumed set out details and separation distances between the developments are based on available information and should be verified by RailCorp.
- Detailed numerical analysis to confirm whether any significant impacts occur for the proposed development. If modelling indicates unacceptable movement, sleeved piles or a transfer beam structure may have to be considered.
- Detailed analysis of the effects of uniform and non-uniform foundation loads (including any anchor or uplift loads) for elements within the defined zone of influence.
- Geotechnical instrumentation may be necessary to demonstrate that the proposed development can proceed safely without adverse impacts on RailCorp infrastructure.

## 8. Request for information from RailCorp

We request the following information from RailCorp:

- Tunnel inspections reports
- Laser profiling details
- Permissible loading requirements and performance criteria for existing infrastructure.

## 9. References

- Department of Railways, New South Wales (1969), Eastern Suburbs railway Sydney, Report on geology of city tunnels stations at Town Hall and Martin Place and appurtenant works, prepared by Snowy Mountains Hydro-Electric Authority.
- Edwards T and R Morgan (1991). Construction of the City Railway, Sydney, Australia
- Hewitt P et al (1999), Genting Centre, Sydney, Deep excavation adjacent to railway tunnels, Eighth ANZ Conference on Geomechanics, Hobart, pp. 2-611 to 2-617.
- Pells PJN, G Mostyn, and BF Walker (1998). Foundations on sandstone and shale in the Sydney region, Australian Geomechanics, December 1998.

## 10. Limitations

This report has been prepared on behalf of Investa to address specific project requirements. Due to the uncertain nature of the proposal, this report has been limited to a conceptual assessment of the geotechnical constraints associated with redevelopment in close proximity to RailCorp's existing rail infrastructure (Eastern Suburbs and Illawarra line, Martin Place station and City Circle line). It is provided as a basis for obtaining in principle support by RailCorp for the Stage 1 Development Application to address planning approval requirements. Further assessment of these constraints would be required at later stages of project development.

Yours sincerely



**Paul Hewitt**

Technical Executive - Geotechnical  
Parsons Brinckerhoff

cc: Investa - Riccardo Alloggia

Encl: Figure 1 Geological and geotechnical plan  
Figure 2 Martin Place station - location, sections and logs of exploration  
Figure 3 Zone of influence diagram Macquarie Street section  
Figure 4 Zone of influence diagram Martin Place section

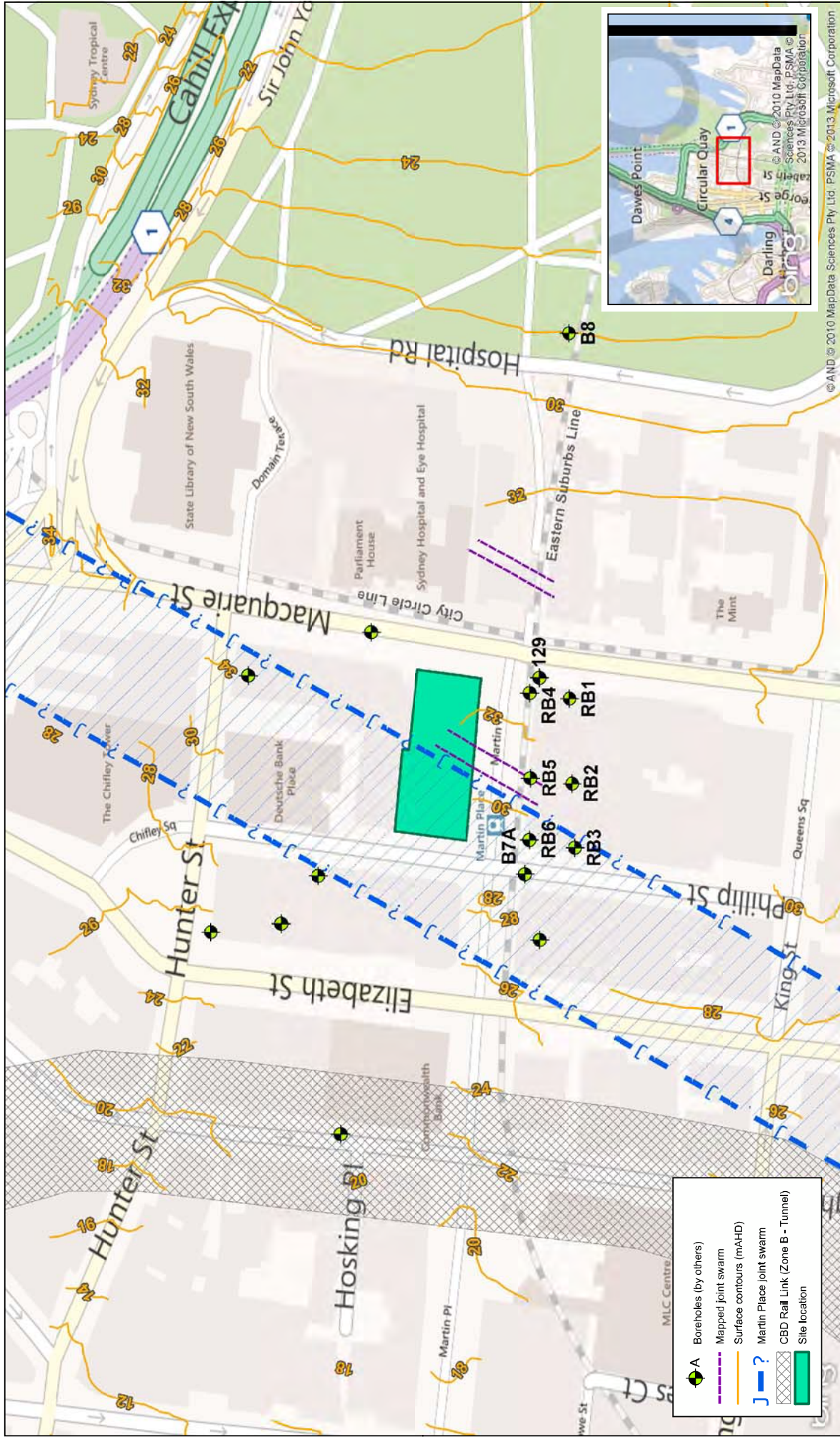

© AND © 2010 MapData Sciences Pty Ltd, PSMA © 2013 Microsoft Corporation

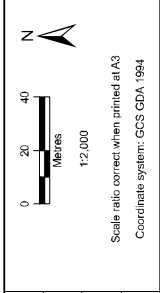

Map no: 201303421_001_LB
Author: DH
Approved by: AF
Date: 14/06/2013

Data source: BING, Dept. of Lands, SEPP 2007, Peils et al 2004, Craig & Rhodes 2013, Dept Railways 1969  
**Note: Borehole positions correct to ±10m**  
 See Fig.2 for rail infrastructure location  
© Phoenix Bracknell Australia Pty Ltd (195). Copyright in the drawings, information and data recorded in this information is the property of PB. This document and the information are solely for the use of the authorised recipient and this document may not be reproduced, stored, copied or processed in whole or part for any purpose other than that for which it was prepared. The recipient shall be liable to the provider for any loss or damage and accepts no responsibility to any third party who may use or rely upon this document or the information. PB is a Certified Quality System ISO 9001, CAPABILITY FOR MLC ON BEHALF OF PERSONS ENTITLED TO THAT TITLE. PB is a member of the Professional Engineers Australia (PEA) network.



**60 Martin Place, Sydney**  
**Figure 1**  
 Geological & geotechnical plan



GS1969 616



60 Martin Place, Sydney  
 Figure 2  
 Martin Place Station - Location, sections & logs of exploration

Mapped joint swarm (Dept. Railways, 1969)  
 Site location  
 City Circle line  
 Eastern Suburbs & Illawarra line

Scale ratio correct when printed at A3  
 Coordinate system: GCS GDA 1994

Map no: 201303421\_002\_D  
 Author: DH  
 Approved by: PH  
 Date: 14/06/2013

Data source: Department of Railways, NSW, 1969



© Parsons Brinckerhoff Australia Pty Ltd (PBA) Copyright in the drawings, information and data recorded in this information is the property of PBA. This document and the information is solely for the use of the addressee and is not to be distributed, copied or reproduced in whole or in part without the prior written consent of PBA. PBA shall not be liable for any errors or omissions in this information, and accepts no responsibility for any third party who may use or rely upon the information for the information. NCS Certified Quality System No. BSO 3005. © APPROVED FOR AND ON BEHALF OF PARSONS BRINCKERHOFF



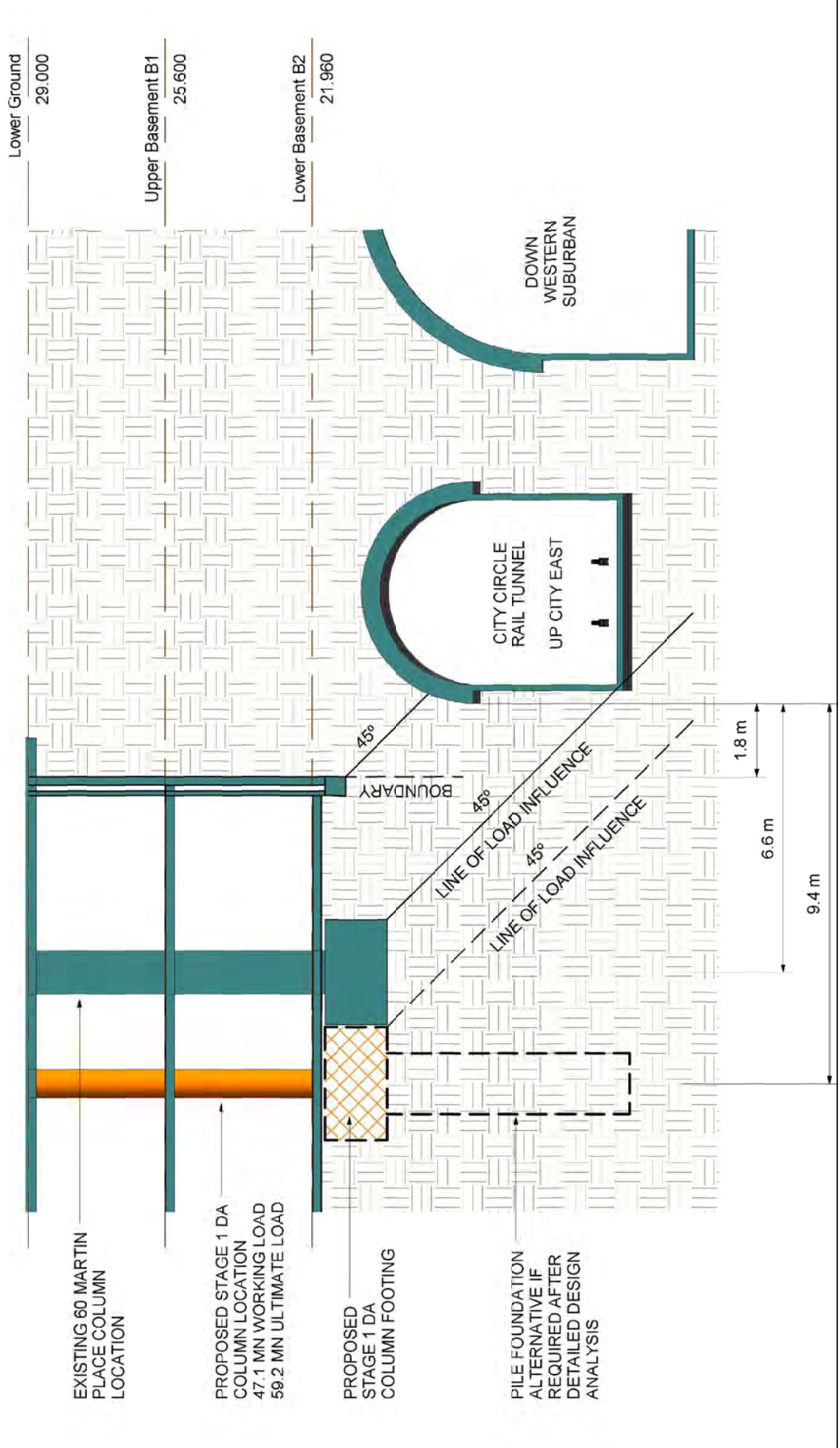

Lower Ground  
29.000

Upper Basement B1  
25.600

Lower Basement B2  
21.960

DOWN  
WESTERN  
SUBURBAN

CITY CIRCLE  
RAIL TUNNEL  
UP CITY EAST

BOUNDARY

LINE OF LOAD INFLUENCE

LINE OF LOAD INFLUENCE

1.8 m

6.6 m

9.4 m

EXISTING 60 MARTIN  
PLACE COLUMN  
LOCATION

PROPOSED STAGE 1 DA  
COLUMN LOCATION  
47.1 MN WORKING LOAD  
59.2 MN ULTIMATE LOAD

PROPOSED  
STAGE 1 DA  
COLUMN FOOTING

PILE FOUNDATION  
ALTERNATIVE IF  
REQUIRED AFTER  
DETAILED DESIGN  
ANALYSIS

	Data source: -	Map no: 201303421_003_A Author: DH Approved by: AF Date: 18/06/2013	No scale ratio. Coordinate system: None
	<p>© Parsons Brinckerhoff Australia Pty Ltd (PBA). Copyright in the drawings, information and data recorded in this information is the property of PBA. This document and the information are solely for the use of the addressee and are not to be distributed, copied or reproduced in whole or in part without the prior written consent of PBA. PBA does not accept any liability for any loss or damage, whether direct or indirect, arising from the use of this information, and accepts no responsibility to any third party who may use or rely upon the document or the information. PBA is a member of the Parsons Brinckerhoff Group of Companies. PBA is an Equal Opportunity Employer. PBA is an Equal Opportunity Employer. PBA is an Equal Opportunity Employer.</p>		
Client Name	60 Martin Place, Sydney Influence zone diagram Macquarie Street section Figure 3		

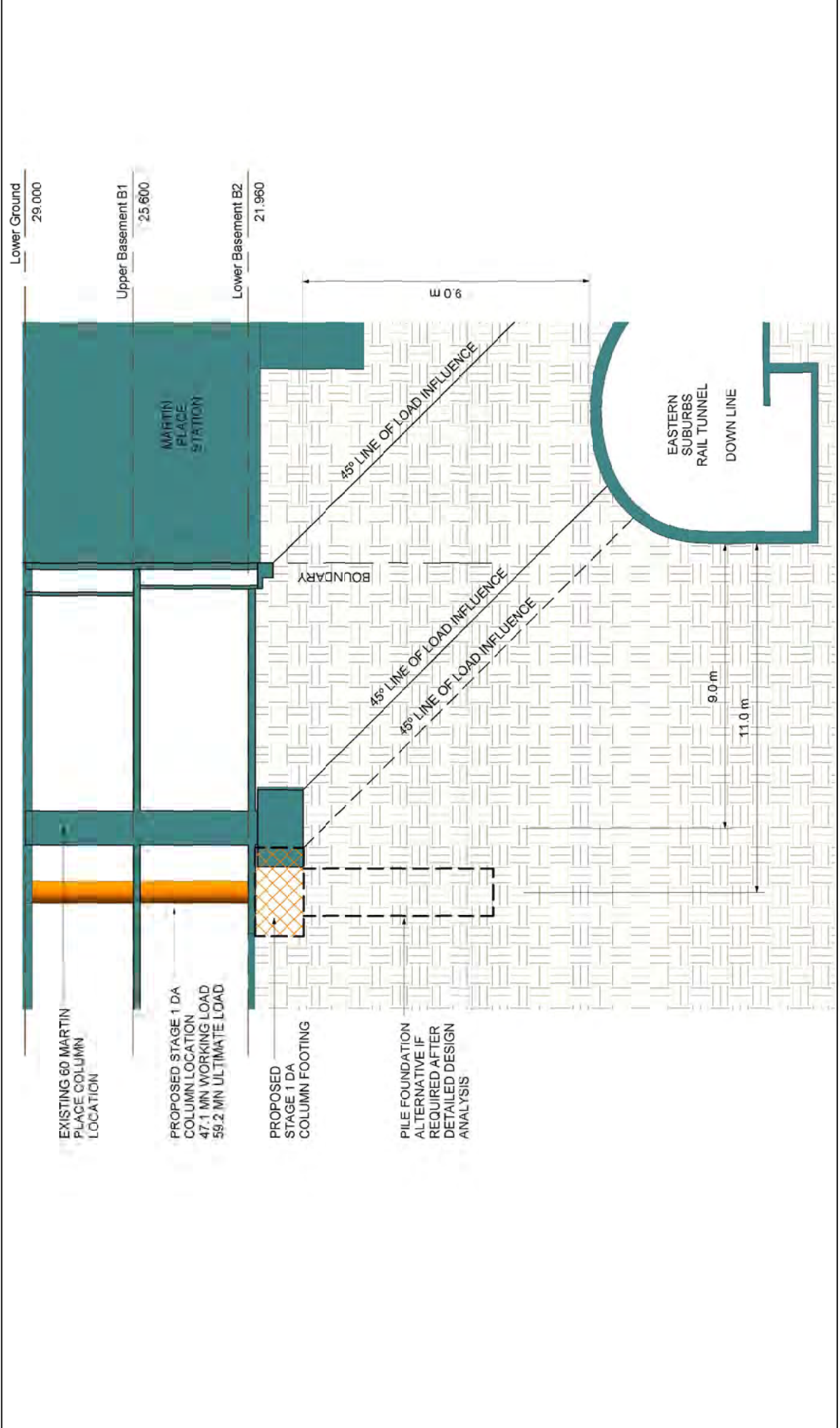

EXISTING 60 MARTIN PLACE COLUMN LOCATION

PROPOSED STAGE 1 DA COLUMN LOCATION  
47.1 MN WORKING LOAD  
59.2 MN ULTIMATE LOAD

PROPOSED STAGE 1 DA COLUMN FOOTING

PILE FOUNDATION ALTERNATIVE IF REQUIRED AFTER DETAILED DESIGN ANALYSIS

Lower Ground 29,000  
Upper Basement B1 25,600  
Lower Basement B2 21,960

BOUNDARY  
45° LINE OF LOAD INFLUENCE  
45° LINE OF LOAD INFLUENCE  
E 0 6

EASTERN SUBURBS RAIL TUNNEL DOWN LINE

9.0 m  
11.0 m

Data source: -



© 2013 Esri. All rights reserved. This information is the property of Esri. This document and the information contained herein are supplied for the use of the addressee only. No warranty is made by Esri for the use of the information in this document for any purpose other than that for which it was provided. Esri disclaims any liability for any third party who may use or rely upon the information, and accepts no responsibility for any third party who may use or rely upon the information. Esri is a registered provider under the Australian Standard for Information Security (ASIS) 4363:2009. Esri is a registered provider under the Australian Standard for Information Security (ASIS) 4363:2009.



Client Name

Map no: 201303421\_004\_A

Author: DH

Approved by: AF

Date: 18/06/2013

No scale ratio.  
Coordinate system: None

**Appendix B – RailCorp Meeting Minutes 5<sup>th</sup> May 2013**

## **Railcorp Briefing - 60 Martin Place, Sydney**

### **Meeting Notes**

Location :	Level 9, 477 Pitt Street, Sydney		
Date :	2 May 2013		
Attendees :	Peter Boyden	(PB)	Railcorp
	Graeme McLaren	(GM)	Railcorp
	Jim Tsirimiagos	(JT)	Railcorp
	Riccardo Alloggia	(RA)	Investa
	Ross Clarke	(RC)	enstruct
	Paul Hewitt	(PH)	Parsons Brinkerhoff

#### **1. RA provided background to the project :**

- a. Investa has formed a joint venture to develop the site, and has agreement in principle with council re building form as a basis for a Stage 1 DA submission.
- b. Stage 1 DA currently being prepared, with a view to submitting in approximately six weeks.
- c. Purpose of this meeting to brief Railcorp pre Stage 1 DA submission and agree ongoing deliverables to enable in principle support for a Stage 1 DA documentation methodology and requirements.

#### **2. RC tabled drawings ( attached) describing the proposed building form and its relation to both Martin Place Station and the City Circle Rail Infrastructure:**

- a. Existing building completed in 1971 and predates Martin Place Station.
- b. Stage 1 DA will propose a building similar to the existing arrangement – ie basement depth, building height and with a southern façade slightly closer to the boundary.
- c. Demolition of the existing building will cause some unloading of the adjacent rock profile and will be studied, however, given proximity and integrity of geotechnical profile, this is not considered critical.
- d. New tower column loads effect on tunnels will need to be analysed, not considered critical, option to sleeve piles and transfer loads below the level of the tunnels would resolve any issues.
- e. Detailed analysis of demolition and transfer of tower column loads as part of the Stage 2 DA.

- f. Vibration isolation will also be studied at a later stage, ie both Rail to Tower, and Tower ( construction) to Rail.
- g. Existing building has a reinforced concrete retaining wall around the perimeter, which will most likely be retained as a temporary perimeter retention system during construction, thus maintaining the integrity of the separation between the construction site and the station.
- h. Existing building is a steel framed structure – easier to demolish, less impact on adjacent station activities during demolition.

### 3. PB comments :

- a. Basement excavation would require a detailed study.
- b. Vibration, acoustic isolation, stray current should be considered.
- c. Subject to formal application, Railcorp supported providing authority for obtaining as-built/historical plans
- d. Railcorp noted Investa to seek survey overlay
  - i. Easements for rail corridors
  - ii. Relationship survey signoff by registered surveyor of site v Railcorp lands
- e. Railcorp to provide guidelines specification when working in proximity of tunnel corridors.

### 4. RCC will prepare a Design Report for distribution and inclusion in the Stage 1 DA, outlining :

- a. Discussion of Site Geology ( PH).
- b. Documentation summarizing :
  - i. Existing building – 60 Martin Place, Martin Place Station and City Circle line.
  - ii. Proposed building – basement and tower.
- c. Proposed tower column – load transfer methodology.
- d. Demolition methodology - steel framed building.
- e. Railcorp requirements – vibration, acoustic etc ( PB).
- f. Stage 2 DA – further analyses.







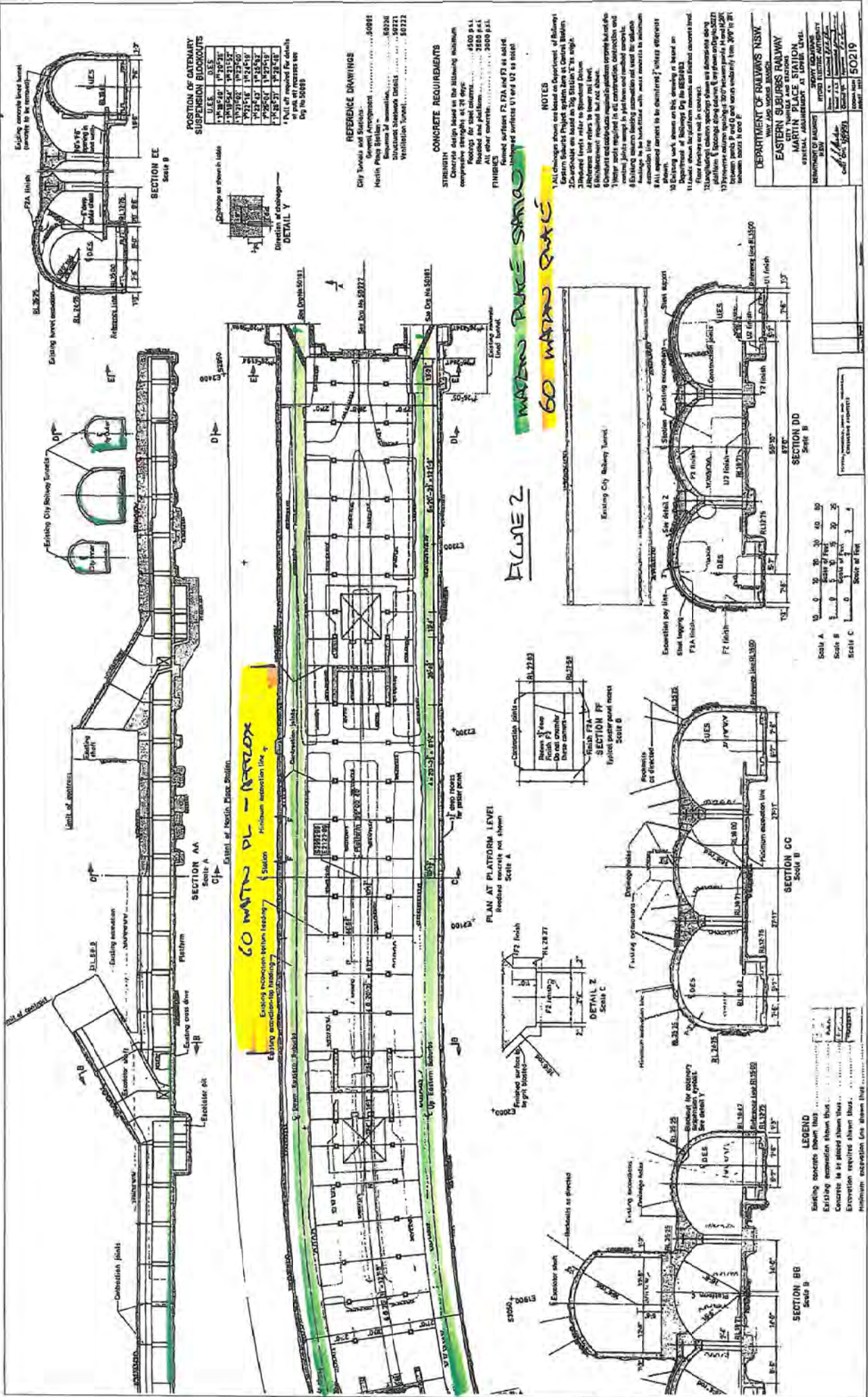

**POSITION OF GATEWAY SUSPENSION BLOKOUTS**

U.E.S.	D.E.S.
M 18' 00"	M 17' 00"
M 18' 50"	M 17' 50"
M 19' 40"	M 18' 40"
M 20' 30"	M 19' 30"
M 21' 20"	M 20' 20"
M 22' 10"	M 21' 10"
M 23' 00"	M 22' 00"
M 23' 50"	M 22' 50"
M 24' 40"	M 23' 40"
M 25' 30"	M 24' 30"

\* Full off required for details at peak of recesses see Dg No 50089

**REFERENCE DRAWINGS**

City Tunnel and Station	50891
Mainline Platform	50892
Structure of mainline	50226
Structure of station	50227
Ventilation Tunnel	50222

**CONCRETE REQUIREMENTS**

Structure design based on the following minimum compressive strength at 28 days

Footings for steel columns	4500 P.A.L.
Recessed steel columns	4500 P.A.L.
All other concrete	3500 P.A.L.

FINISHES  
 Formed surface F2, F3 and F3 as noted  
 Formed surface U1 and U2 as noted

**NOTES**

- All changes shown on this drawing are the responsibility of the Department of Railways.
- Eastern Suburbs Railway Station is located at Martin Place.
- 22a provide on based on the Station E's single.
3. Proposed levels refer to the Station Datum.
4. Proposed levels refer to the Station Datum.
5. Proposed levels refer to the Station Datum.
6. Proposed levels refer to the Station Datum.
7. Heavy work required in the construction, construction and erection of the structure.
8. All proposed work to be completed unless otherwise stated.
9. Existing work shown on this drawing is based on the Department of Railways Dg No 50892.
10. Existing work shown on this drawing is based on the Department of Railways Dg No 50892.
11. Existing work shown on this drawing is based on the Department of Railways Dg No 50892.
12. Existing work shown on this drawing is based on the Department of Railways Dg No 50892.
13. Proposed work shown on this drawing is based on the Department of Railways Dg No 50892.
14. Proposed work shown on this drawing is based on the Department of Railways Dg No 50892.
15. Proposed work shown on this drawing is based on the Department of Railways Dg No 50892.

**DEPARTMENT OF RAILWAYS NSW**  
 Wm. J. G. Jones, Director  
**EASTERN SUBURBS RAILWAY**  
**MARTIN PLACE STATION**  
 STRUCTURAL DRAWING AT LOWER LEVEL

NO.	DATE	BY	CHECKED	SCALE
1	1/1/50	J. G. Jones	J. G. Jones	1/2" = 1'-0"
2	1/1/50	J. G. Jones	J. G. Jones	1/2" = 1'-0"
3	1/1/50	J. G. Jones	J. G. Jones	1/2" = 1'-0"
4	1/1/50	J. G. Jones	J. G. Jones	1/2" = 1'-0"
5	1/1/50	J. G. Jones	J. G. Jones	1/2" = 1'-0"
6	1/1/50	J. G. Jones	J. G. Jones	1/2" = 1'-0"
7	1/1/50	J. G. Jones	J. G. Jones	1/2" = 1'-0"
8	1/1/50	J. G. Jones	J. G. Jones	1/2" = 1'-0"
9	1/1/50	J. G. Jones	J. G. Jones	1/2" = 1'-0"
10	1/1/50	J. G. Jones	J. G. Jones	1/2" = 1'-0"

**60 MATN DL - NSRLOX**  
 Existing section before testing  
 Station  
 Minimum section line

**FIGURE 2**  
**MARTIN PLACE STATION**  
**60 MATN DL - NSRLOX**

**LEGEND**

Existing concrete shown that	.....
Existing excavation shown that	.....
Concrete to be placed shown that	.....
Excavation required shown that	.....
Minimum section line shown that	.....

**Scale A** 0 10 20 30 40 50  
**Scale B** 1 2 3 4 5 6 7 8 9 10  
**Scale C** 0 10 20 30 40 50  
 Scale of feet

OP OF ROOF\_RL148145  
 \_RL147.85  
 27\_RL142.6  
 26\_RL138.7  
 25\_RL134.8  
 24\_RL130.9  
 23\_RL127.  
 22\_RL123.1  
 21\_RL119.2  
 20\_RL115.3  
 19\_RL111.4  
 18\_RL107.5  
 17\_RL103.6  
 16\_RL99.7  
 15\_RL95.8  
 14\_RL91.9  
 13\_RL88.00  
 12\_RL84.1  
 11\_RL80.2  
 10\_RL76.3  
 9\_RL72.4  
 8\_RL68.5  
 7\_RL64.6  
 6\_RL60.7  
 5\_RL56.8  
 4\_RL49  
 3\_RL45.1  
 2\_RL41.2  
 1\_RL37.3  
 over ground\_RL33.4  
 over ground\_RL29  
 31\_RL23.6  
 32\_RL19.265

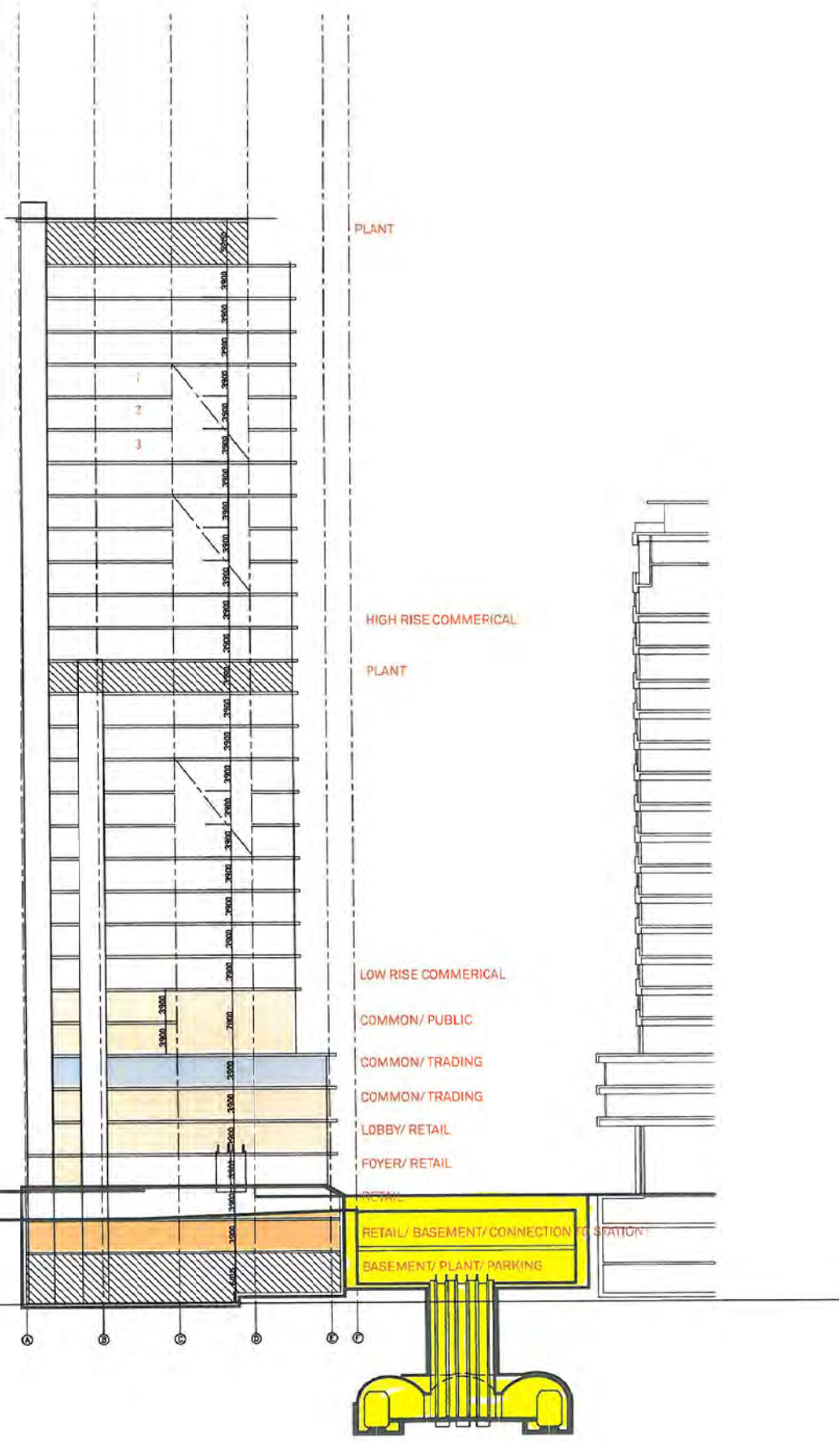

HASELL  
© 2013

**Section B**

01 05 2013  
Sketch showing approximate location of station

80 Martin Place  
Investa



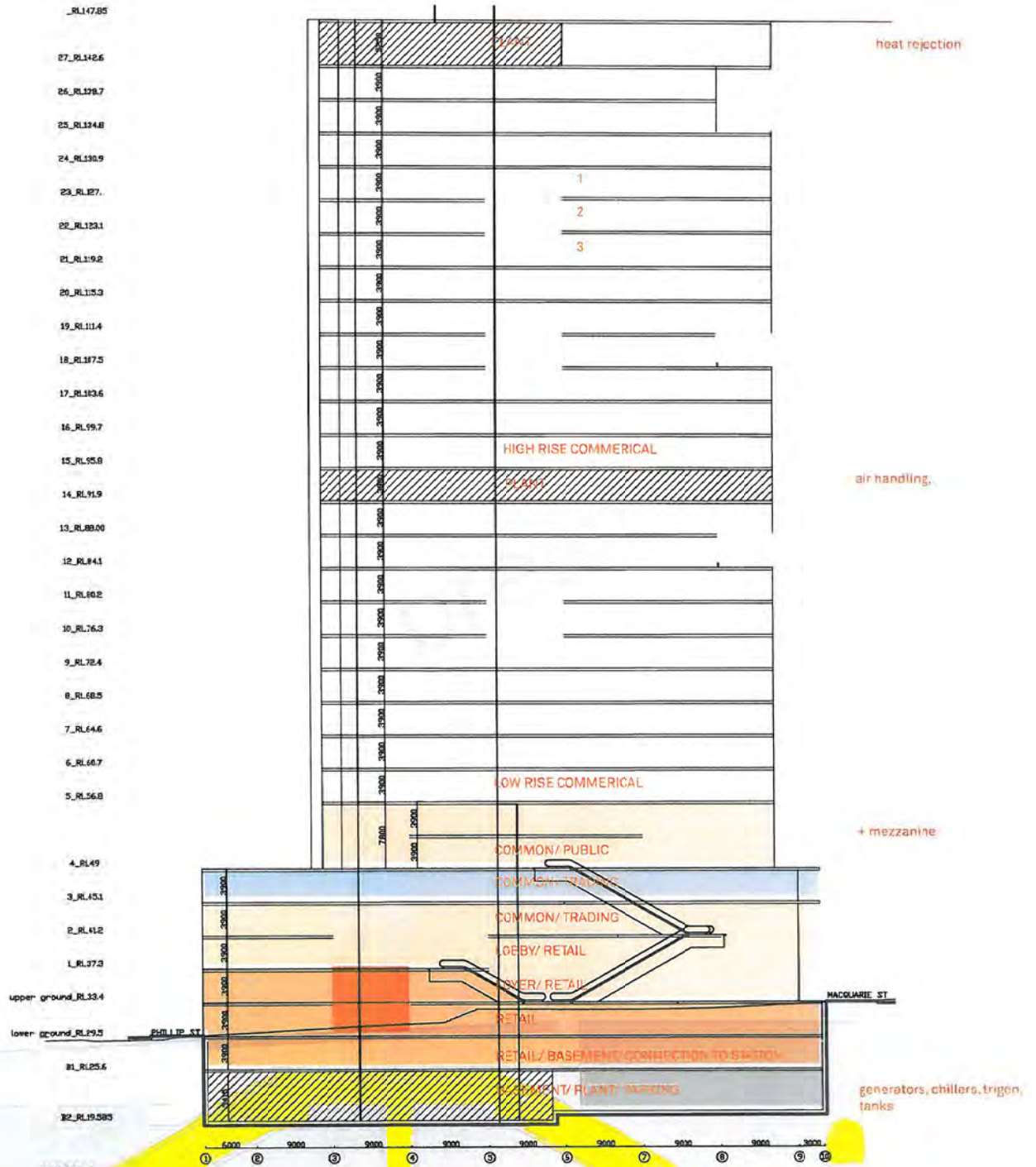

**Section A**

01 05 2013  
 Sketch showing approximate location of station

60 Martin Place  
 Investa

JOB No. 4586	
BY RCC	SHEET No. SK 1
CHECKED	DATE 21.3.13

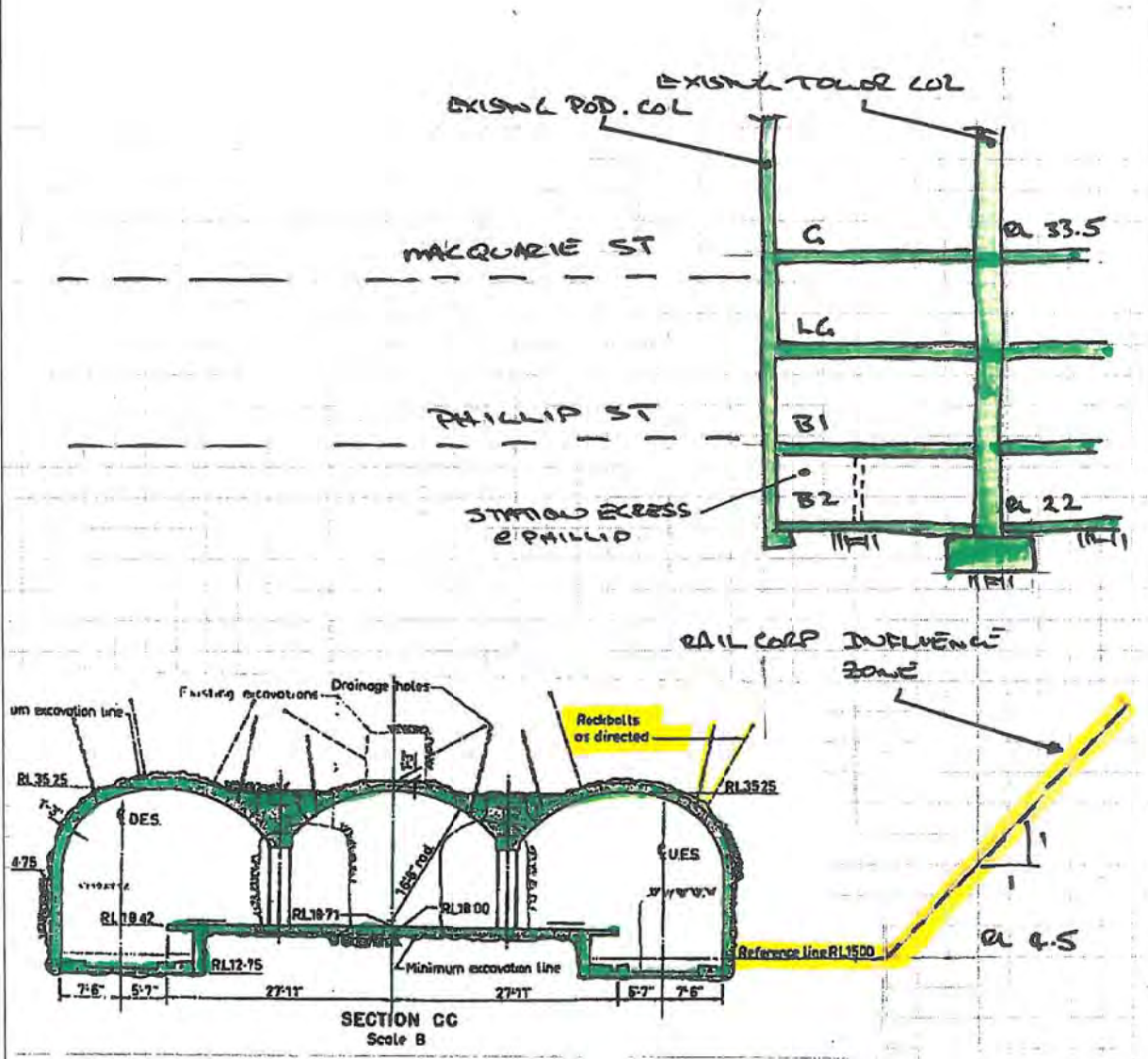

SECTION THROUGH GO MARTIN PL EXISTING  
MTD BLOCK - LOOKING WEST

FIGURE 3